

Lab-Volt®

TRAINING SYSTEMS FOR TELECOMMUNICATIONS

- Digital and Analog Communications
- Simulation Programs for Telecommunications
- Telephony
- Radar Technology
- Microwave Technology
- Antennas
- Fiber Optic Communications

TELECOMMUNICATIONS





Building Training Systems for the Global Workplace

For over four decades, Lab-Volt has provided state-of-the-art systems for technician training in the basic and most advanced applications of electricity and fluid power, microprocessors and controls, process instrumentation, and telecommunications.

Today, Lab-Volt's highly effective approach to training and education has earned us the distinction as the leading North American producer of hands-on technical training systems. Key to our success has been our ability to anticipate the applications of new technologies and develop modular training systems that allow us to address the basic, as well as specialized, needs of industry and education. In our approach to training and education, we begin by carefully defining each new training need. Next, we methodically design and create the best curriculum, instrumentation,

tems are modular and open-ended so that students may enter or exit a program at many points. Lab-Volt training systems bring technical theory to life, teaching the latest technologies along with valuable troubleshooting, critical thinking, and reasoning skills.

Lab-Volt maintains a staff of educators, instructional system designers, and engineers who are always available to assist teachers, training directors, and administrators in designing program content, selecting or modifying equipment and software, and providing professional teacher training.

In designing our laboratory equipment, we ensure compatibility with international power requirements that prevail throughout North America, Africa, Asia, Europe, the Middle East, South America, and Southeastern Asia. Whether at a high school or community college in the United States, an air traffic control center in Saudi Arabia, or a technical institute in the Philippines, Lab-Volt training systems provide state-of-the-art teaching and classroom management tools built on computer-mediated platforms that deliver, manage, and control the educational process.

Lab-Volt's systems have been used to train technicians who are successfully employed in leading multinational companies such as General Telephone & Electronics, Lockheed Aviation, United States Steel, Western Electric and Westinghouse, Intel and Micron Semiconductor, Ford Motor Company, General Motors, IBEW, Bell Telephone of New Jersey, and many others. In addition, Lab-Volt-trained technicians hold positions throughout the world at leading colleges, universities, educational ministries, and military installations.

FACET®, Lab-Volt Simulation Systems®, Lab-Volt Automation®, and Tech-World® by Lab-Volt are among the most widely used integrated technology education systems today. Trainees in over 30,000 schools, industrial sites, and military installations in over 50 countries worldwide use Lab-Volt systems to learn the skills that are necessary to keep up with the world's rapid technological growth well into the next millennium.



delivery method, management platform, and laboratory furniture and configuration to suit real-world training goals and the real needs of students and instructors.

Lab-Volt training systems are carefully balanced to provide a solid theoretical grounding in the subject matter, along with numerous and diverse hands-on applications. By design, our first-quality, industry-standard training sys-



Technical Training Systems

- **Electric Power and Control**

- » Electromechanical
- » Power Electronics and Drives
- » Power Transmission, Distribution, and Protection
- » Industrial Controls

- **Telecommunications**

- » Digital and Analog Telecommunications
- » Radar Technology
- » Microwave Technology
- » Antenna
- » Telephony
- » Fiber Optic Communications

- **Manufacturing/Mechatronics**

- » Automation and Robotics
- » Fluid Power
- » Instrumentation and Process Control
- » Refrigeration, Air Conditioning, and Heating
- » Exploratory Technology

- **Tech-Design®**

- » Communications
- » Transportation
- » Construction
- » Manufacturing
- » Bio-Related
- » Family & Consumer Sciences

- **Tech-World®**

- » Applications in Manufacturing

- **Computer-Based Electronics Training System (FACET®)**

- » Basic Principles of Electricity and Electronics
- » Circuit Simulations
- » Digital and Microprocessor Electronics
- » Telecommunications
- » Industrial Electronics

CENTRAL SALES & MANUFACTURING OFFICES

LAB-VOLT SYSTEMS, INC.

Farmingdale, New Jersey, USA 07727
Telephone (732) 938-2000 Fax (732) 774-8573
Toll Free U.S. Telephone (800) LAB-VOLT
E-MAIL: us@labvolt.com

LAB-VOLT LIMITED

Québec, Québec, CANADA G2N 2K7
Telephone (418) 849-1000 Fax (418) 849-1666
Toll Free Canada Telephone (800) LAB-VOLT
E-MAIL: ca@labvolt.com

LAB-VOLT'S WEB SITE

www.labvolt.com

Known for Excellence in Technical Training

Introducing Lab-Volt's Award-Winning Training Systems for Analog & Digital Communications

Lab-Volt's Telecommunications Training Systems form an essential training program for students with interest in the dynamic and growing communications industry. Because the Lab-Volt Telecommunications program is completely modular in design, students may enter it at any level according to their career goals and abilities.

The Telecommunications curriculum incorporates hands-on experience with the basic principles and operations of electric and electronic communications systems. Through computer-assisted learning, students are able to progress from intermediate to advanced levels of analog and digital systems, to applications in microwave, fiber optics, antenna, and radar technologies.

Simulation-assisted training is now offered for the Analog and Digital Communications Training Systems under the innovative LVSIM®-ACOM and LVSIM®-DCOM platforms, the virtual instrumentation of Lab-Volt's Data Acquisition and Management (LVDAM®-COM) software, and the Lab-Volt Virtual Instrumentation package, Model 1250.

Using LVSIM-ACOM and LVSIM-DCOM Microsoft® Windows®-based programs, students are able to set up a virtual workstation using the computer desktop as a laboratory for demonstrating the principles of analog and digital communications. Both platforms are Windows® Vista compatible. This innovative approach reduces lab time and costs while increasing student learning and retention.

FACET®

Seven modules in the Telecommunications program derive from Lab-Volt's award-winning Computer-Based Electronics Training System (FACET). These include:

- Analog Communications
- Digital Communications 1
- Digital Communications 2
- Fiber Optic Communications
- Digital Signal Processor
- Transmission Lines
- QPSK/ OQPSK/ DPSK

FACET is a modular program available as a manual or computer-based (Windows) system. Each module requires a FACET base unit in order to power and control the circuit board.

For more information on the integrated FACET learning system and the exciting opportunities it offers students in the study of advanced telecommunications technology, please see pages 5 to 15 or contact Lab-Volt or your representative for the Electronics Product Guide.

With the aid of the FACET electronic classroom-management system, GradePoint 2020™, instructors are able to perform on-line vital management tasks such as generating multiple class rosters, analyzing test results, storing previous work, converting data to numerical grades, monitoring unit-by-unit progress, averaging group grades, providing comparative data for curving or weighting class grades, tracking competency achievement and producing detailed competency reports, and more.

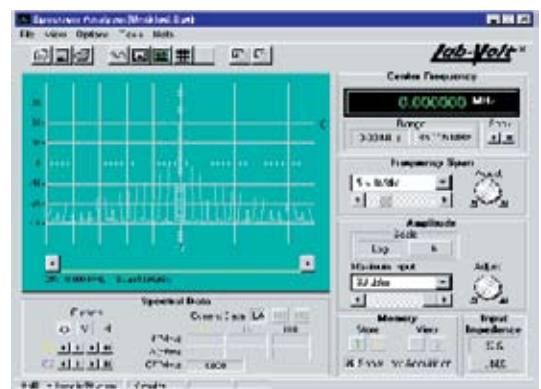
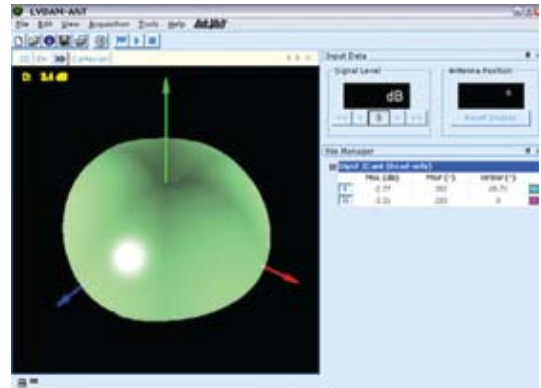



Table of Contents

Product Highlights

Communications Technologies Training System.....6
 Computer-Based Electronics Training System (FACET®) 7
Modules feature a powerful management system and simulation software.

FACET® TELECOMMUNICATIONS SYSTEMS

FACET System Base Units9
 FACET Analog Communications10
 FACET Digital Communications 111
 FACET Digital Communications 212
 FACET Fiber Optic Communications.....13
 FACET Digital Signal Processor14
 FACET Transmission Lines15
 FACET QPSK/OQPSK/DPSK16
 Virtual Instrument Package17

ANALOG & DIGITAL COMMUNICATIONS SYSTEMS

Communications Technologies Training System.....18
 Analog Communications Training System 20
 Digital Communications Training System21
 LVSIM-ACOM & LVSIM-DCOM.....22
Simulation and Virtual Instruments for Analog & Digital Communications
 LVDAM-COM Data Acquisition and Management for Telecommunications.....26

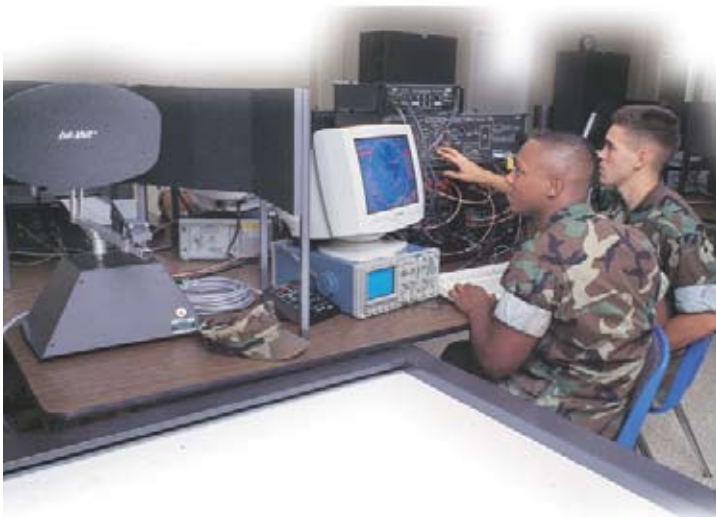

TELEPHONY, MICROWAVE, AND RADAR TECHNOLOGIES

Telephony Training System.....28
 Microwave Technology Training System.....31
 Antenna Training and Measuring System32
 Radar Training System.....34

ORDERING INFORMATION

Courseware39

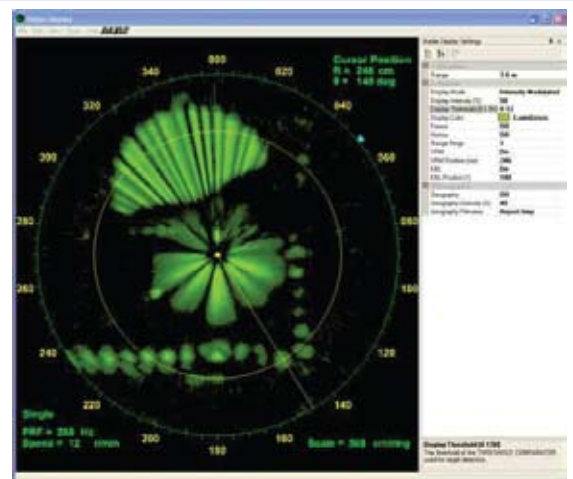

Communications Technologies Training Systems

"Communications Training System with tremendous flexibility at a reduced cost."

The Lab-Volt Communications Technologies Training System, Model 8087, is a complete, state-of-the-art, digital communications training system, including instruments.

Specially designed for hands-on training, this system facilitates the study of many different types of digital modulation/demodulation technologies such as PAM, PWM, PPM, PCM, Delta Modulation, ASK, FSK, and BPSK as well as spectrally efficient technologies such as QPSK, QAM, and ADSL. Advanced communications technologies such as Spread Spectrum (direct sequence and frequency hopping) and CDMA are also covered. The system is designed to reflect the standards commonly used in modern communications systems.

The Communications Technologies Training System is based on a Reconfigurable Training Module (RTM) and the Lab-Volt Communications Technologies (LVCT) software. This approach allows for tremendous flexibility at a reduced cost. Each of the communications technologies to be studied is provided as an application that can be selected from a menu. Once loaded into the LVCT software, the selected application configures the RTM to implement the communications technology hardware and presents a specially-designed user interface for the student.

The courseware for the Communications Technologies Training System consists of a series of student manuals covering the different technologies as well as instructor guides that provide the answers to procedure step questions and to review questions. The Communications Technologies Training System and the accompanying courseware provide a complete study program for these important technologies.

Designed to reflect the standards commonly used in practical digital communications systems.

- System-Oriented
- Real System and real frequencies – not simulations
- Modular
- Based on current technologies and standards
- MATLAB® Import/Export in ADSL applications
- Compatible signal levels
- Front-panel access to signals
- Fault insertion capabilities
- Low-power for safety and compatibility
- Short-circuit-proof

The Reconfigurable Training Module, Model 9431-1, used in the 8087 System is the same platform used for many other Lab-Volt Training Systems, such as the 8086 Telephony Training System and 8096 Radar Training System. Unlike conventional, hardware-based training systems that use a variety of physical modules to demonstrate different technologies and instruments, the Communications Technologies Training System uses the Lab-Volt Communications Technologies (LVCT) software along with a Reconfigurable Training Module (RTM) to implement hardware; together these components provide tremendous flexibility at a reduced cost.

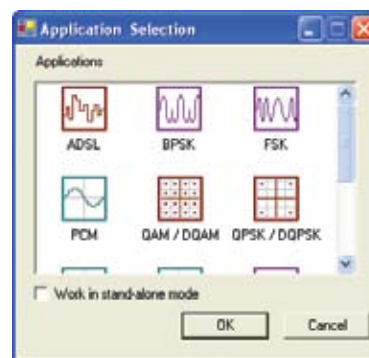

The Windows®- based Lab-Volt Communications Technologies (LVCT) software provides the user interface and configures the RTM to implement the communications technology selected by the user.

The RTM Connections diagram identifies the RTM inputs and outputs and shows the physical connections.

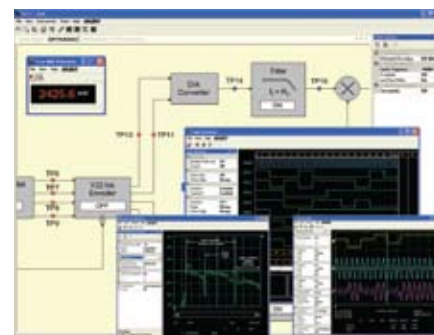
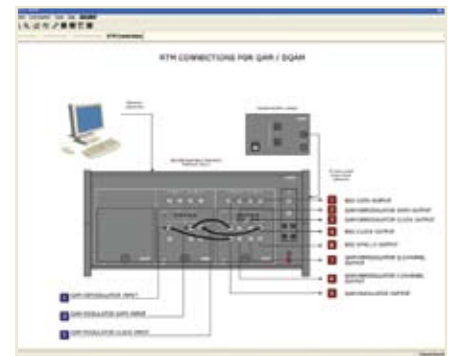

- The LVCT software components include:
- Oscilloscope
 - True RMS Voltmeter
 - Logic Analyzer
 - Spectrum Analyzer
 - Constellation Viewer

FACET®

Modules Feature Powerful Management System and Simulation Software*

The following Telecommunications modules** are part of Lab-Volt's award-winning Computer-Based Electronics Training System (FACET®):

- Analog Communications
- Digital Communications 1
- Digital Communications 2
- Fiber Optic Communications
- Digital Signal Processor
- Transmission Lines
- QPSK/ OQPSK/ DPSK

With these modules, instructors can use the following features to enhance their teaching effectiveness and customize their curriculum:

Tech-Lab® FACET® System Utility

- **Application Launch:** A single click activates software applications – those included with the curriculum and others that instructors may add.
- **Teacher Annotations:** Teachers can add supplementary information, notes, or instructions within the curriculum.
- **Course Content Editing:** Easy-to-use graphical tools enable the addition of information (transfer annotations to curriculum screens), audio and video content, and even new modules.
- **Assessment Editing:** Instructors can edit pre- and post-tests, competencies, and scenario-based assessment grading with rubrics; and create tests with linked competencies.
- **Preferences for curriculum operation:** Teachers can activate media features, such as narration, closed captioning, MPEG videos, and teacher annotations; topic preferences such as prerequisites and quiz aids; and several more options.
- **Access to students' electronic journals:** Instructors can communicate with students about notes they save in the journals, projects, their progress, etc.

Upon enrollment in the class, students receive the journals and these other online, learning-enhancement tools to maximize their training experiences:

- **Internet Link Resource:** An educational portal provides links to related web sites to expand and reinforce learning.
- **Text-to-Speech:** Once activated by the instructor, students can click on selected text to have the text narrated. Narration is possible in multiple languages for both existing content and any text that teachers add.

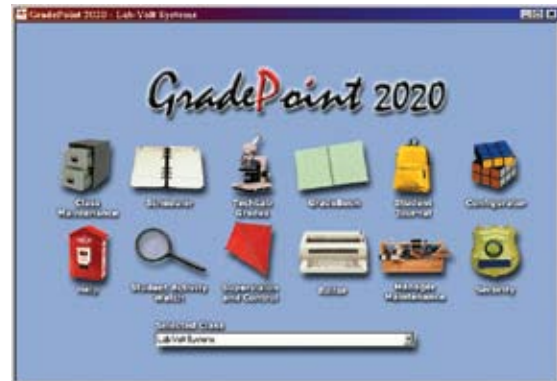

GradePoint 2020™ Electronic Classroom Manager and Gradebook

- **Real-time data collection:** Students' performance data on tests and activities is automatically collected in the software. This enables instructors to provide instant feedback on students' achievements, as well as areas in need of additional support.
- **Easy grade viewing:** Instructors can examine grades from pre- and post-tests, on-line activities and assignments, and overall grades in one grid.
- **Automatic computing and recording of grades.**
- **Simple report generation:** A click of a button will generate any of 20 reports.
- **Manual setting of grade weights and competency thresholds.**

NetOp School® Networked- Classroom Software

A single click within GradePoint 2020 provides access to these additional capabilities:

- **Supervision and Control:** From their own computers, instructors can observe students as they work, identify who needs assistance, and provide one-on-one instruction via remote-control access to a student's computer.
- **Demonstration broadcasts:** Instructors can teach by example from their own or a student's computer, to any number of students.
- **Announcement posting:** Teachers can send messages to the entire class in one easy step.
- **Real-time chats:** Instructors can communicate with selected students in writing or audio (with headphones) without interrupting others.
- **Attention button:** Instructors can bring the class to attention with a single click.

** See pages 9 to 17 for details on these modules.

NetOp School® also minimizes administrative time by:

- Launching programs on students' computers with a single command.
- Remotely rebooting students' computers after modifying the system.

State-of-the-Art Circuit-Simulation Software with FACET Modules

The FACET curriculum incorporates state-of-the-art software for studying, testing, and designing analog and digital circuits: MultiSIM from Electronics Workbench. This software features easy-to-use Electronic Design Automation (EDA) tools for design engineers, educators, and students.

MultiSIM offers the following features:

- Schematic Capture
- Advanced Component Database
- SPICE Simulation
- RF Design Kit
- Comprehensive selection of options for analysis and display of results
- VHDL for fast, high-performance simulations; includes a product manager, built-in text editor, and a tool that writes custom shell codes
- Verilog, a fast, accurate simulator for operation at the behavioral, gate, and switch levels
- Co-simulation, for designing central logic in the middle of printed circuit boards, or the interfacing between digital chips and the rest of the board
- Project and Team Design, facilitates information sharing and a tighter design integration.

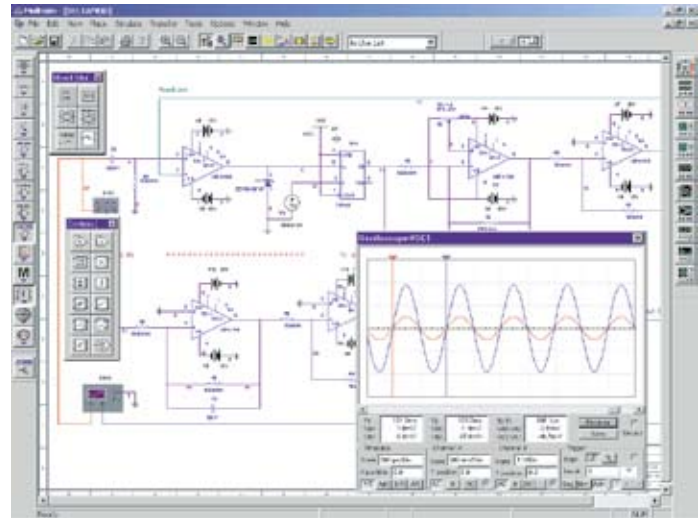

This graphic is a basic screen shot of the workspace of MultiSIM when it is opened and a circuit has been created and is being analyzed. The window in the lower right corner of the screen is an instrument (oscilloscope), and the two palettes (gray rectangles) along the left side are opened component bins.

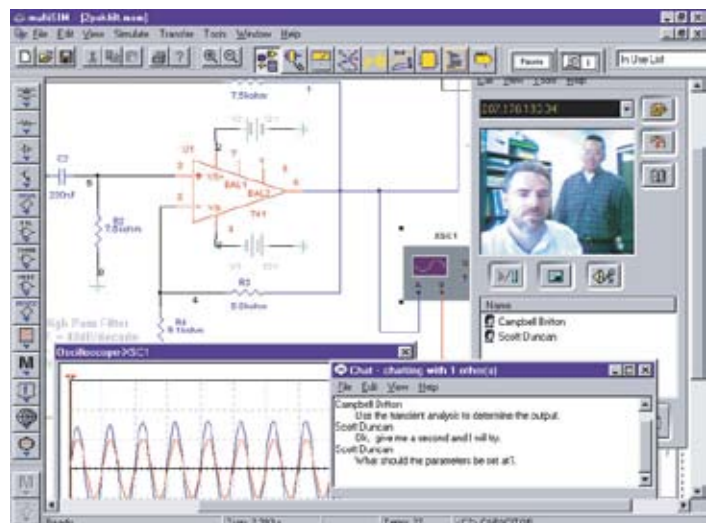

MultiSIM's Internet Design Sharing allows colleagues in different locations to work on the same circuit as if they were in the same room, controlling and examining the circuit together in real time. Users can be around the corner, across town, or on opposite sides of the globe.

FACET[®] System Base Units



*Model 91000-30,
manual base unit
with built-in power
supply*

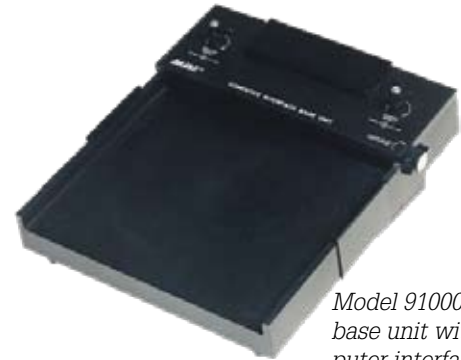

*Model 91000-50, USB
base unit with com-
puter interface and
built-in power supply*

The FACET base units provide students with a means of operating, analyzing, and troubleshooting each FACET circuit board. Additionally, the base units provide protection and voltage conditioning circuitry to run each FACET board. Base units are available for manual or computer-based systems.

GENERAL FEATURES

- Distributed ± 15 and variable ± 10 Vdc power to the various circuit training blocks. Coarse and fine controls are provided to adjust the variable ± 10 Vdc supplies.
- Self-protection against short-circuit, reverse-voltage, and over-voltage conditions.
- Long-life zero insertion force (ZIF) connector, with a rotary knob that locks the training module into the base unit. The ZIF connector itself is protected from damage by built-in stops.
- The fingers on the connectors are gold-plated for added durability.

MANUAL BASE UNIT FEATURES

The manual system base unit (Model 91000-30) comes with an accessory kit containing terminal posts, connectors, adapters, and patchcords required to perform experiments on each FACET training module. Power is connected to the base by standard banana-plug test cables. Two light-emitting diodes (LEDs) the base unit also indicate the presence of an external power source and the appropriate power conditions to perform experiments. A locking cover houses 12 fault-insertion switches; 32 toggle switches are available for student circuit modification.

COMPUTERIZED BASE UNIT FEATURES

The computerized base unit (91000-50) contains 32 reed relays controlled by commands from the host microcomputer. Model 91000-50 is linked to the microprocessor via a USB port. Circuit modifications (CMs) and faults are switched in and out automatically by the software. A message on a student's computer screen indicates that a CM or

fault is activated. In the troubleshooting exercises, faults are inserted automatically by the computer, thereby freeing the instructor to assist students with individual activities.

COMPUTERIZED FACET SYSTEM REQUIREMENTS

All systems require:

- FACET Base Unit
- Multimeter
- Dual-Trace Oscilloscope
- Audio Function Generator
- Courseware: manual (hard copy) or computer-based (Windows)
- 100% compatible Windows[®] PC, Microsoft[®] Windows 2000 Professional with Service Pack 3 or higher, Pentium III class CPU (500 or higher), 512 MB RAM, 40 GB hard drive (minimum 2000 MB free space), CD/DVD-ROM combo, SVGA Monitor capable of 32-bit color display at 1024 x 768 resolution, 16 MB video card, 16 Bit Sound Blaster-compatible, full-duplex sound card

FACET® ANALOG COMMUNICATIONS MODEL 91018

With the Analog Communications circuit board, students can configure, operate, and troubleshoot the following circuits: Amplitude Modulation (AM) Transmitter and Receiver, Single-Sideband (SSB) Transmitter and Receiver, Frequency Modulator (FM), Phase Modulator (PM), Quadrature Detector (FM Demodulation), Phase-Locked Loop (PLL), and PLL FM Detector.

In this course, students receive hands-on circuit training and acquire skills to measure radio signals with an oscilloscope. Students also learn the functions of oscillators, filters, amplifiers, LC networks, modulators, limiters, mixers, and detectors in communication circuits. Circuit modifications and faults allow students to develop troubleshooting skills.

The Analog Communications circuit board is designed to operate in the FACET system environment.

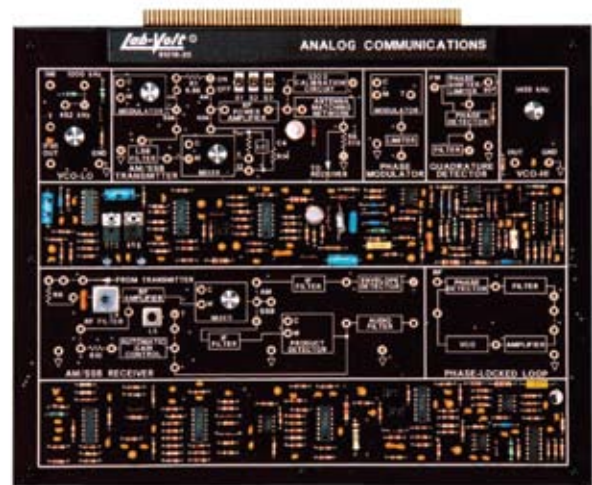

TOPIC COVERAGE

- Analog Communications Concepts
- Circuit Board Familiarization
- Amplitude Modulation (AM)
- RF Power Amplifier
- Balanced Modulator
- RF Stage
- Mixer, IF Filter, and Envelope Detector
- Balanced Modulator and LSB Filter
- Mixer and RF Power Amplifier
- RF Stage, Mixer, and IF Filter
- Product Detector and Automatic Gain Control
- Frequency Modulation (FM) and Phase Modulation (PM)
- Demodulation (Quadrature Detector)
- PLL (Phased-Locked Loop) Circuit and Operation
- FM Detection with a PLL
- Troubleshooting Basics
- Troubleshooting Analog Communications Circuits

FEATURES

Seven circuit blocks:

- Amplitude Modulation (AM) Transmitter and Single-Sideband (SSB) Transmitter
- AM Receiver and SSB Receiver
- Frequency Modulator (FM)
- Phase Modulator (PM)
- Quadrature Detector (Demodulation)
- Phase-Locked Loop (PLL) Circuit
- PLL FM Detector

ESTIMATED PROGRAM HOURS

35 hours

LANGUAGE VARIATIONS

English, Spanish, French, Portuguese

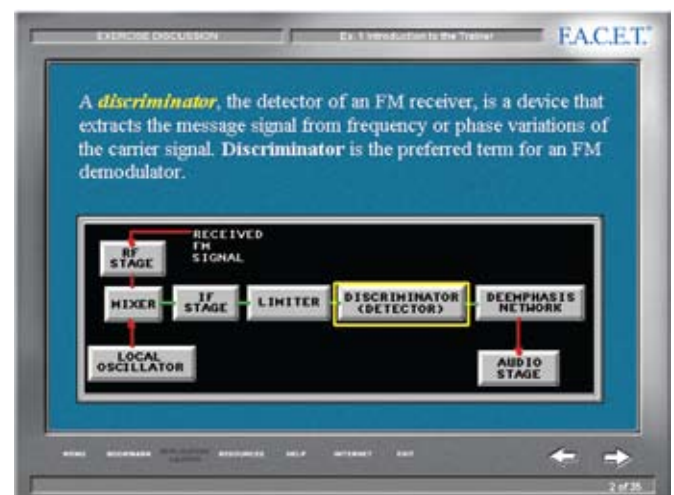

FACET® DIGITAL COMMUNICATIONS 1 MODEL 91022

With the Digital Communications 1 circuit board, students can configure, operate, and troubleshoot the following circuits: Pulse-Amplitude Modulation (PAM), Pulse-Time Modulation (PTM), Pulse-Code Modulation (PCM), Pulse-Amplitude Modulation/Time-Division Multiplexing (PAM-TDM), and Delta Modulation (DM). Each circuit block contains a modulator for transmission and a demodulator for reception.

Also in this course, students learn the operation and function of the following: sampler, sample/hold, adder, ramp generator, comparator, limiter, filter, CODEC, PLL, compressor, expander, integrator, differentiator, latched compare, speaker amplifier, and channel simulator. Circuit modifications and faults allow students to develop troubleshooting skills.

The Digital Communications 1 circuit board is designed to operate in the FACET system environment.

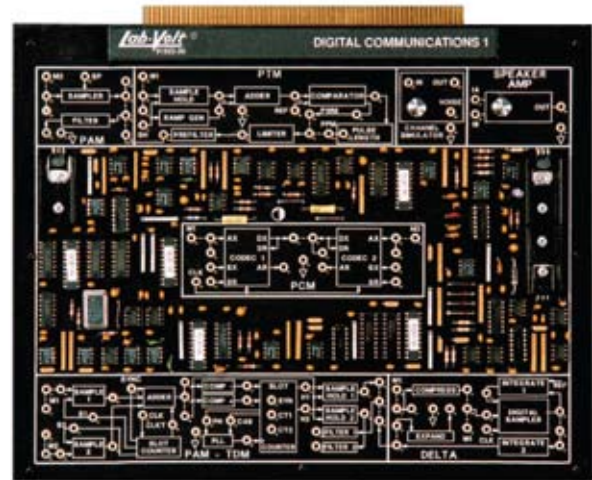

TOPIC COVERAGE

- Concepts of Digital Communications
- Circuit Board Familiarization
- Pulse-Amplitude Modulation (PAM) Signal Generation
- PAM Signal Demodulation
- PAM - Time-Division Multiplexing (TDM) Transmission
- PAM - TDM Reception
- Pulse-Time Modulation (PTM) Signal Demodulation
- PTM Signal Generation
- Pulse-Code Modulation (PCM) Signal Generation and Demodulation
- PCM Signal TDM
- Delta Modulation (DM) Transmitter
- DM Receiver and Noise
- Channel Bandwidth
- Channel Noise
- Troubleshooting Basics
- Troubleshooting Digital Communications 1 Circuits

FEATURES

- Circuit blocks for the study of PAM, PTM, PCM, PAM-TDM, and DM
- Each circuit block contains a modulator for transmission and a demodulator for reception.
- Built-in Channel Simulation and speaker amplification circuitry.
- The Channel Simulator circuit block enables students to investigate the effects of noise and channel bandwidth on pulse and digital modulation signals.
- The Speaker Amp circuit block permits students to connect a speaker and listen to the signals.
- Communication signals are synchronized for easy display.

ESTIMATED PROGRAM HOURS

35 hours

LANGUAGE VARIATIONS

English, Spanish, French, Portuguese

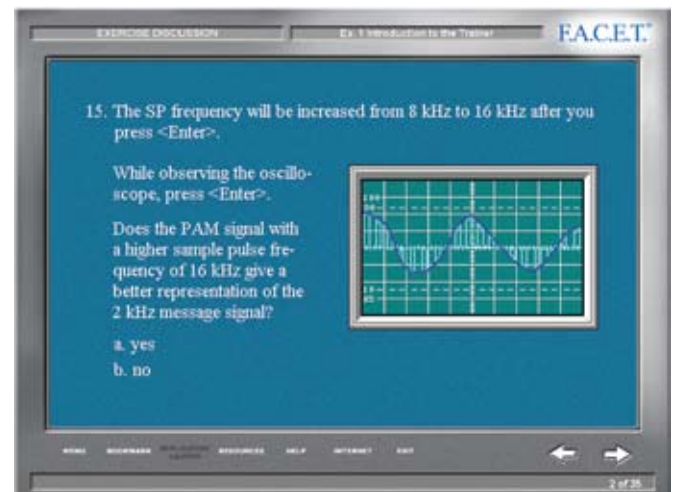

FACET® DIGITAL COMMUNICATIONS 2 MODEL 91023

With the Digital Communications 2 circuit board, students can configure, operate, and troubleshoot the following circuits: NRZ, RZ, Manchester encoding and decoding, clock synchronizer, frequency-shift keying (FSK) generation, FSK asynchronous and synchronous detection, phase-shift keying (PSK) generation, PSK synchronous detection, amplitude-shift keying (ASK) generation, ASK asynchronous and synchronous detection, channel effects, and FSK/DPSK (differential phase-shift keying) modem.

Following a carefully designed instructional program, students will become familiar with all components of the board; will be able to isolate, identify, and test a series of circuits; and will perform troubleshooting exercises to demonstrate mastery of the course objectives.

The Digital Communications 2 circuit board is designed to operate in the FACET system environment.

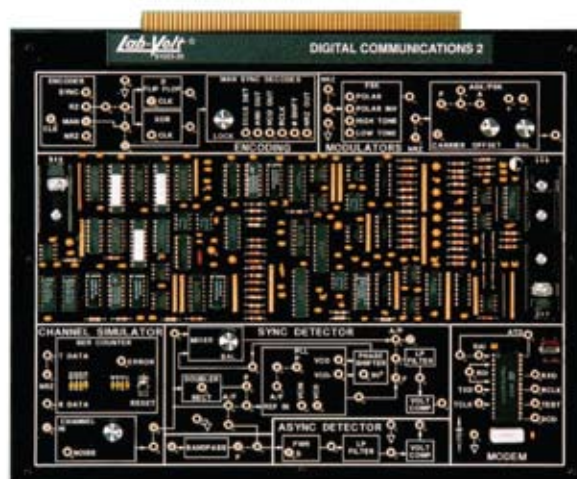

TOPIC COVERAGE

- Circuit Board Familiarization
- Introduction to Digital Transmission
- Encoding
- Decoding
- Frequency-Shift Keying (FSK) Signal Generation
- FSK Asynchronous Detection
- FSK Synchronous Detection
- Phase-Shift Keying (PSK) Signal Generation
- PSK Synchronous Detection
- Amplitude-Shift Keying (ASK) Signal Generation
- ASK Asynchronous Detection
- The Channel Simulator
- Effects of Noise on ASK and PSK Signals
- Effects of Noise on Asynchronously and Synchronously Detected FSK Signals
- Operation of an FSK Modem
- Operation of a DPSK (differential phase-shift keying) Modem
- Troubleshooting Basics
- Troubleshooting Digital Communications 2 Circuits

FEATURES

- Circuit blocks allow for the study of line encoding, modulators, channel simulator, sync. detector, and modems.
- The Channel Simulator circuit block and a bit error rate (BER) counter enable students to evaluate the effects of noise on ASK and PSK modulated carrier signals.
- The Modem circuit block contains an FSK/DPSK modem IC, which students use in a loop-back mode to observe the entire signal path.
- Communication signals are synchronized for easy display.

ESTIMATED PROGRAM HOURS

40 hours

LANGUAGE VARIATIONS

English, Spanish, French, Portuguese



FACET® FIBER OPTIC COMMUNICATIONS MODEL 91025

The Fiber Optic Communications circuit board provides students with a solid foundation in the theory and practice of fiber optic communications technology. The eleven circuit blocks provide hands-on experimentation with several varieties of fiber optic transmission and reception.

Through the interactive CBL (computer-based learning) format, the student learns the principles of both analog and digital transmission and reception using fiber optic communication links. The circuit board may be used with the FACET base unit or as a stand-alone trainer.

TOPIC COVERAGE

- Circuit Board Familiarization
- Introduction to Fiber Optic Communications
- Scattering and Absorption Losses
- Connectors and Polishing
- Numerical Aperture and Core Area
- Bending Loss and Modal Dispersion
- Light Source
- Driver Circuit
- Source-to-Fiber Connection
- Light Detector
- Output Circuit
- Fiber Optic Test Equipment
- Optical Power Budgets
- Analog Communications
- Digital Communications*
- Troubleshooting

FEATURES

- Circuit blocks include a fiber optic transmitter and receiver, analog and digital transmitters, analog and digital receivers, an RS-232 interface, a photo-transistor, light-emitting diodes (LEDs), and more.
- FACET base unit or stand-alone operation
- ST connections
- Multimode 62.5/125 cm glass, and 980/1000 cm plastic cables
- High-speed 820 nm transmitter
- Integrated PIN photodiode receiver
- Digital and analog communications channels
- Full handshake RS-232 interface using Time-Division Multiplexing (TDM) and Manchester coding
- On-board microphone and speaker

ESTIMATED PROGRAM HOURS

- 30 hours

LANGUAGE VARIATIONS

English, Spanish, French, Portuguese

* For this exercise, the computer interface requires optional equipment: FACET 32-Bit Microprocessor module (91017-20) plus accessories: 9V power supply (91730), Cable (31217-00) and Adapter (31216-00). Additional option includes Polishing Kit (92026).

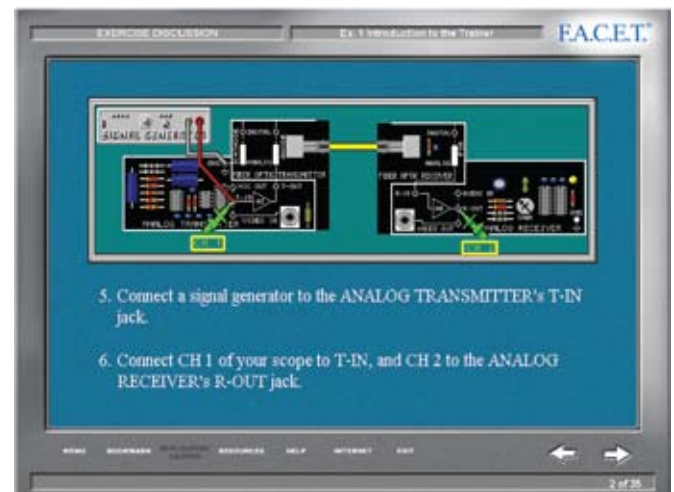

FACET® DIGITAL SIGNAL PROCESSOR MODEL 91027

The Digital Signal Processor (DSP), Model 91027, is the first trainer on the market to teach students the control devices and data-processing capabilities of a DSP. Through the operation of the DSP circuit board and accompanying courseware, students gain insight into the internal architecture of a DSP. The unit can be used either with the FACET base unit or as a stand-alone trainer.

The module contains a DSP (TMS320C50), a DC power source, a microphone preamplifier, and an audio amplifier. An eight-position dipswitch, a four-digit display, push-button switches, and analog input and output connections to the DSP enable students to probe the structure of the TMS320C50 DSP. The auxiliary I/O circuit block has headers that enable students to design additional experiments or prototypes of DSP-controlled circuits.

Through a serial link to a computer, Windows-based debugger software enables direct interaction with the DSP registers, memory, and peripherals.



TOPIC COVERAGE

- Introduction to the Digital Signal Processor (DSP) Circuit Board
- The Assembler and the Debugger
- Numerical Formats
- Arithmetic in a DSP
- Memory Structure
- Address Generation Unit
- Program Control
- Pipelining
- Peripherals
- Signal Processing: The FIR Filter

ESTIMATED PROGRAM HOURS

25 hours

LANGUAGE VARIATIONS

English, Spanish, French, Portuguese

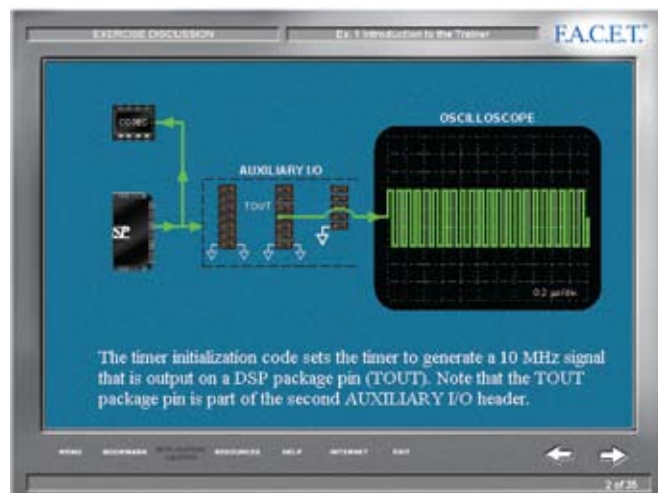
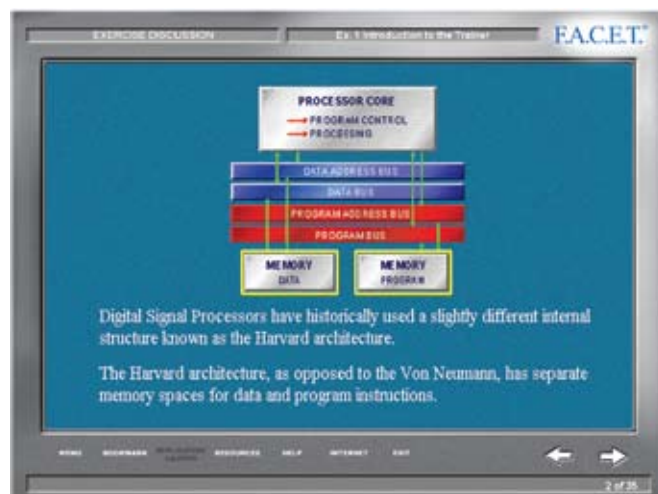

FACET® TRANSMISSION LINES MODEL 91028

The Transmission Lines circuit board, Model 91028, provides students with the theory and measurement skills required to implement and test transmission line designs. Students first learn the principles and operational characteristics of transmission lines. They then learn how to conduct transmission line measurements under transient and sinusoidal steady-state conditions. Finally, students acquire a valuable foundation in the theory and practice of time-domain reflectometry (TDR), as well as impedance matching and transformation.

The circuit board uses two RG-174 coaxial cables, each a length of 24 meters (78.7 feet). They can be used separately or connected end-to-end. Each line has five probing points that permit observation and measurements of signals along the line, using an oscilloscope.

Two generators are provided to study the transmission line behavior: a step generator that produces a 50-kHz square-wave voltage for transient behavior testing, and a signal generator that produces a sinusoidal voltage of variable frequency (5 kHz - 5 MHz) for steady-state behavior testing. Each generator has several BNC outputs providing different output impedances.

A load section, consisting of a configurable network of resistors, inductors, and capacitors, permits connection of different load impedances to the receiving end of each line.

The circuit board may be used in the FACET base unit, or as a stand-alone unit.

TOPIC COVERAGE

- Introduction to the Transmission Lines Circuit Board
- Velocity of propagation
- Behavior of transmission line under various load impedances
- Attenuation and Distortion
- Reflection coefficient at the load and generator
- Measuring complex load impedances
- Using time domain reflectometry (TDR) to locate discontinuities on a line
- Standing waves and standing-wave ratio
- Reflection coefficients, return/mismatch losses, and transmission coefficients at the load
- Measuring line attenuation and insertion losses
- Measuring the length of a line
- Resonant lines and impedance transmission

ESTIMATED PROGRAM HOURS

25 hours

LANGUAGE VARIATIONS

English

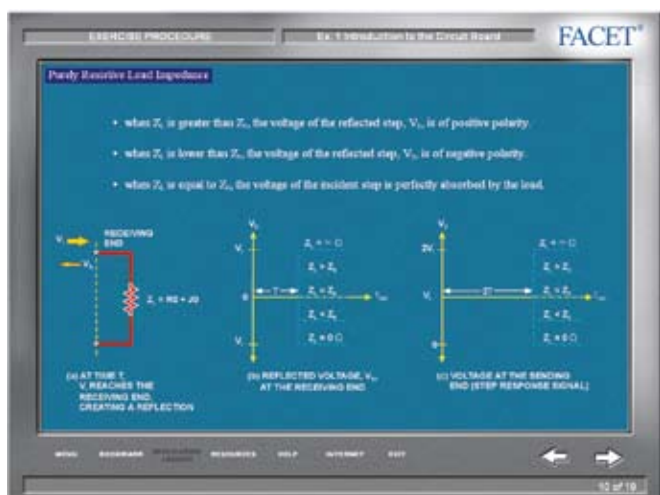

FACET® QPSK/OQPSK/DPSK MODEL 91029

Phase-shift keying (PSK) is a method of digital communication in which the phase of a transmitted signal is varied to convey information.

The QPSK/OQPSK/DPSK board provides students with the theory and measurement skills required to implement and test different types of PSK modulation and demodulation techniques used in pulse-coded modulation (PCM) schemes.

The student first learns the principles and operational characteristics of unipolar and bipolar signals in a baseband transmission. Next, the student measures and compares BPSK, QPSK, OQPSK, and DPSK signals in the time and frequency domains using an oscilloscope and spectrum analyzer, respectively. Lastly, the student becomes familiar with all components of the board; isolates, identifies, and tests a series of circuits; and performs troubleshooting exercises to demonstrate mastery of the course objectives.

TOPIC COVERAGE

- Digital modulation
- Baseband signals
- Passband signals
- Partitioning of pulse streams
- Signal constellations for MPSK
- General MPSK equations
- Heterodyning baseband signals with a carrier
- Unipolar and bipolar signals in time domain
- Unipolar and bipolar signals in the frequency domain
- Binary PSK (BPSK) modulation and demodulation
- Quadratic PSK (QPSK modulation and demodulation
- Offset QPSK (OQPSK) modulation and demodulation
- Differential PSK (DPSK) encoding and decoding

ADDITIONAL FEATURES

- Communication signals are synchronized for easy display
- Digital signals observed in both time and frequency domains
- Courseware interfaces with the Lab-Volt Virtual Instrument, Model 1250
- Built-in adjustable NRZ GENERATOR provides various bit pattern streams
- Adjustable bandwidth channel simulator

ESTIMATED PROGRAM HOURS

20 hours

LANGUAGE VARIATIONS

English

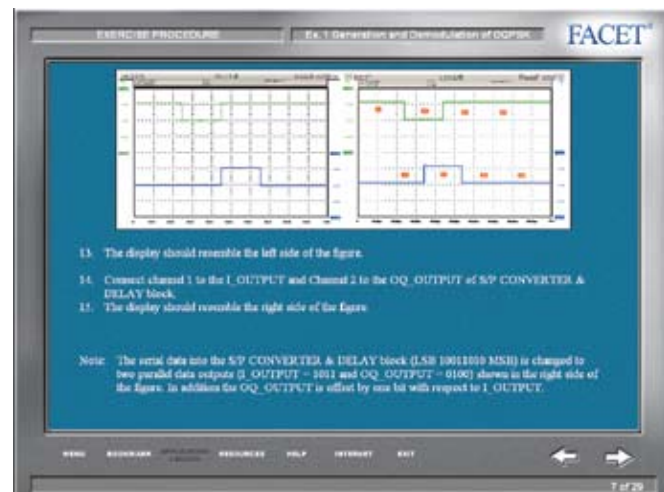
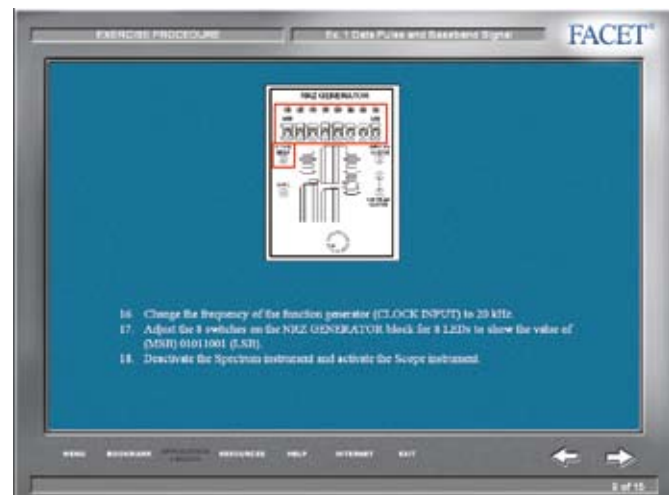

VIRTUAL INSTRUMENT PACKAGE MODEL 1250

The Lab-Volt Virtual Instrument Package, Model 1250, is a lightweight, compact, and portable desktop unit that replaces standard desktop test equipment (FACET Digital Multimeter/AF Generator, Model 1247, and oscilloscope) with a powerful, space-saving instrumentation package and software that gives students state-of-the-art tools to measure, analyze, observe, and report the results of electronic circuit tests. It can be used with the following Microsoft® Windows operating systems: 95, 98, NT 4.0 (with service pack 6), 2000, Me, and XP.

Fully integrated with the FACET Electronics Training program, the Lab-Volt Virtual Instrument Package enables students to conduct all experiments that would otherwise be performed with separate testing instruments.

The complete Lab-Volt Virtual Instrument Package includes a desktop unit containing the following instruments:

- Digital Storage Oscilloscope
- Multimeter
- Function Generator
- Spectrum Analyzer
- Transient Recorder

The package also includes all necessary software, cables, a user manual, two oscilloscope probes (switchable 1:1 - 1:10), test leads, and a data acquisition instrument that can be connected to the parallel printer port of a personal computer. The Lab-Volt Virtual Instrument Package can be powered from 110 to 240 Vac (50/60 Hz) or 12 to 24 Vdc for portability.

Students use the keyboard, mouse, and computer screens to control and display the five measuring instruments. The Windows-based software menu and tool bars allow inexperienced students to carry out measurements easily. Measured data can be printed out or stored on a floppy disk or network.

With the Lab-Volt Virtual Instrument Package, students gain experience using modern measurement techniques that prepare them for real jobs in today's electronics industries.

DUAL-CHANNEL OSCILLOSCOPE

The dual-channel oscilloscope has a 25 MS/s sampling rate in dual-channel mode, and 50 MS/s sampling rate in single-channel mode. Cursors are available to perform voltage, time, phase, and frequency measurements on the displayed signal. An external trigger input is located at the back of the unit.

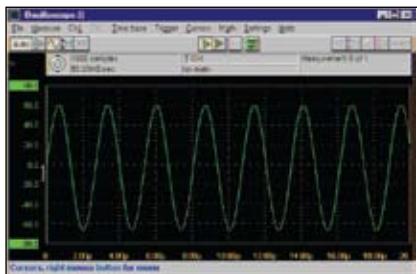

MULTIMETER

The Multimeter measures voltage (AC/DC), current (AC/DC), resistance, and frequency. The maximum AC frequency response is 5 MHz. Several types of measurements -- such as true RMS, peak-to-peak, mean, dBm, max, min, power, and duty cycle -- are available.

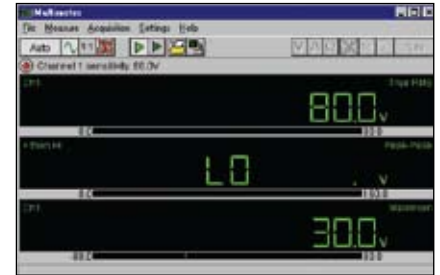

SIGNAL GENERATOR

The single-channel Signal Generator produces sine, square, and triangle waveforms with a frequency range of 0.01 Hz to 500 KHz. The output amplitude is 0-20 Vp-p (no load) with an output impedance of 50 Ω.



SPECTRUM ANALYZER

The dual-channel Spectrum Analyzer graphically displays voltage as a function of frequency. It has a maximum frequency range of 25 MHz with an accuracy of 0.1%. The software supports six window functions.



TRANSIENT RECORDER

The dual-channel Transient Recorder measures slowly changing events, such as temperature and pressure changes. Measuring time between events is 0.01 sec to 300 sec. Cursors are available to analyze the measured signals.



COMMUNICATIONS TECHNOLOGIES TRAINING SYSTEM MODEL 8087



The Lab-Volt Communications Technologies Training System is a state-of-the-art communications training system, including instruments. Specially designed for hands-on training, this system facilitates the study of many different types of digital modulation/demodulation technologies such as PAM, PWM, PPM, PCM, Delta Modulation, ASK, FSK, and BPSK as well as spectrally efficient technologies such as QPSK, QAM, and ADSL. Advanced communications technologies such as Spread Spectrum (direct sequence and frequency hopping) and CDMA are also covered. The system is designed to reflect the standards commonly used in modern communications systems.

The Communications Technologies Training System is based on a Reconfigurable Training Module (RTM) and the Lab-Volt Communications Technologies (LVCT) software. One of the benefits of this approach is flexibility at a reduced cost. Each of the communications technologies to be studied is provided as an application that can be selected from a menu. Once loaded into the LVCT software, the selected application configures the RTM to implement the communications technology hardware and presents a specially-designed user interface for the student.

You can upgrade your system at any time to cover additional technologies simply by purchasing additional communications technology applications. This approach effectively “future-proofs” your training system.

TOPIC COVERAGE

- PAM/PWM/PPM
- PCM/DPCM/Delta Modulation
- ASK/FSK/BPSK
- QPSK/ DQPSK
- QAM/DQAM
- ADSL
- Spectrum Analysis
- Advanced Telecommunications such as CDMA and Spread Spectrum (FHSS and DSS)

FEATURES

- Flexible, future-proofed, open system using a high performance DSP-based Reconfigurable Training Module (RTM) with slots for up to three plug-in interface modules.
- Two plug-in interface modules are included: the Data Acquisition Interface and the Analog/Digital Output Interface.
- Applications include on-screen block diagrams of circuits with numerous Test Points and/or Test Busses for connecting virtual instruments.
- The LVCT software includes a number of virtual instruments, such as an oscilloscope, logic analyzer, spectrum analyzer, and a true RMS voltmeter (depending on the application). The ADSL application provides two constellation viewers.
- Fault-insertion capability allows the teaching of troubleshooting.
- Comprehensive courseware provides theory and step-by-step laboratory procedures for each technology.
- Applications such as ADSL include provision for exporting and importing tables of data in a MATLAB[®]-compatible format.

REQUIRED EQUIPMENT

Computer (Pentium 4 or better), running Windows[®] XP or Windows[®] Vista, including a 3D graphics card (dual monitor support is recommended) and a Fast Ethernet (100Mb/s) network interface adapter.

SYSTEM ENHANCEMENT

- Communications Technologies Host Computer (with dual monitors, LVCT software pre-installed)
- Dual trace oscilloscope

SYSTEM VOLTAGES

120, 220, 240 V - 50/60 Hz

ESTIMATED PROGRAM HOURS

- Volume 1 35 Hours
- Volume 2 40 Hours
- Volume 3 25 Hours
- Volume 4 20 Hours
- Volume 5 20 Hours
- Volume 6 20 Hours

LANGUAGE VARIATIONS

English, Spanish, French

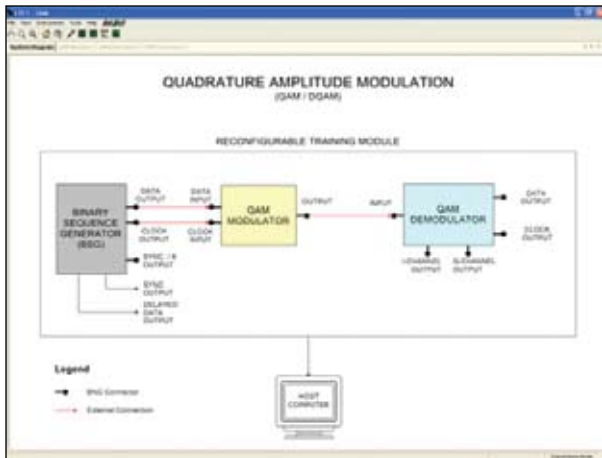

The System Diagram shows the overall system and interconnections for the selected application.

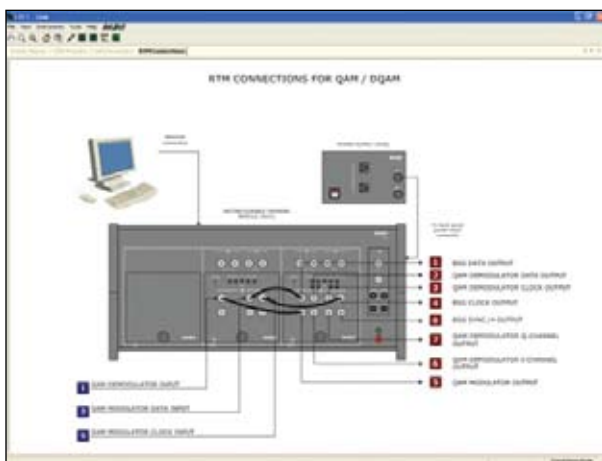

The RTM Connections diagram identifies the RTM inputs and outputs and shows the physical connections.

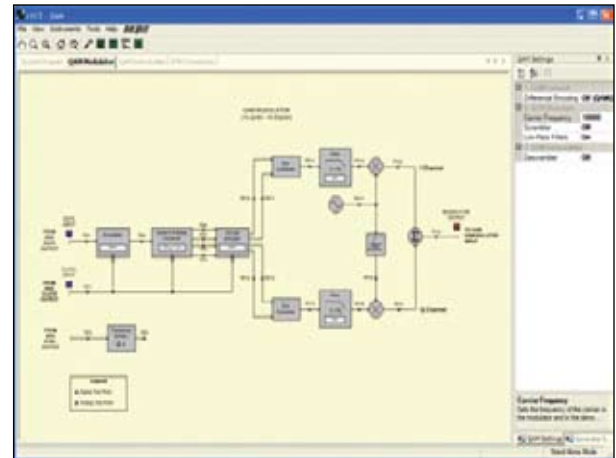

The Lab-Volt Communications Technologies (LVCT) software provides the user interface and configures the RTM to implement the communication technology selected by the user.

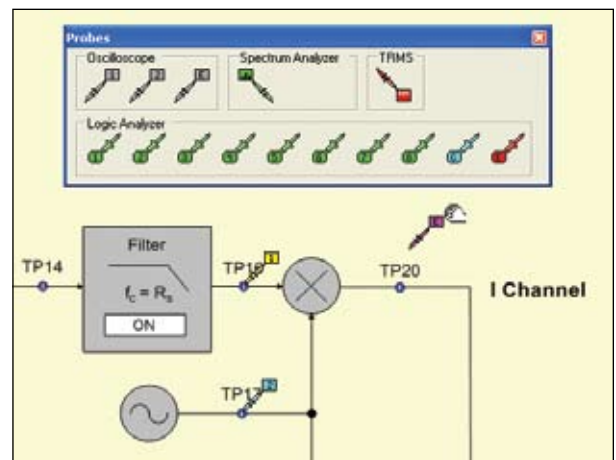

Probes can be dragged from the Probes bar and connected to circuit Test Points in order to observe signals using the virtual instruments.

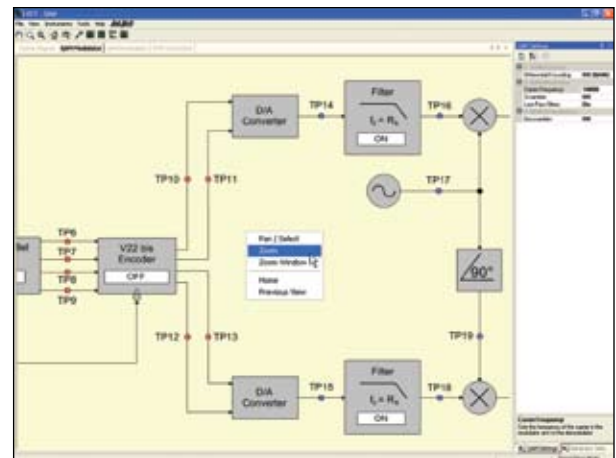

Circuit diagram shows the functional blocks of each circuit. Pan and Zoom functions allow easy navigation.

ANALOG COMMUNICATIONS TRAINING SYSTEM MODEL 8080

The Lab-Volt Analog Communications Training System is the first in a comprehensive series of advanced systems-level programs that use the latest communications technologies to teach analog communications theories and practices in a variety of training environments.

The system consists of six instructional modules supported by six instrumentation modules, and courseware that provides hands-on exercises in the generation, transmission, and reception of amplitude, double sideband, single sideband, frequency, and phase-modulated signals [Amplitude Modulation (AM), Double-Sided Modulation (DSB), Single-Sideband Modulation (SSB), Frequency Modulation (FM) and Pulse Modulation (PM)]. A door on the top of each instructional module provides access to circuit boards, test points, and fault-insertion switches.

Model 8080-A0, an alternate system, includes the LVDAM-COM software and interface, Model 9407, which replaces three of the six instrumentation modules (Frequency Counter, True RMS Voltmeter/Power Meter, and Spectrum Analyzer) of the standard system and an oscilloscope, with a set of computer-based instruments. See page 24 for additional information.

TOPIC COVERAGE

VOLUME 1, INSTRUMENTATION

- Concepts and Equipment
- Spectral Analysis
- Modulation Fundamentals

VOLUME 2, AM/DSB/SSB

- Amplitude Modulation (AM) Fundamentals
- The Generation of AM Signals
- Reception of AM Signals
- Double-Sideband (DSB) Modulation
- Single-Sideband (SSB) Modulation
- Troubleshooting AM Communications Systems

VOLUME 3, FM/PM

- Frequency Modulation (FM) Concepts
- Fundamentals of Frequency Modulation
- Narrowband Angle Modulation
- Wideband Frequency Modulation
- Generation of FM Signals
- Reception of FM Signals
- Frequency Division Multiplexing
- Noise in Frequency Modulation
- Troubleshooting FM Communications Systems



FEATURES

- System applications cover the areas of generation, transmission, and reception of amplitude, double sideband, single sideband, frequency, and phase-modulated signals.
- Instructor-enabled fault switches enhance and develop students' troubleshooting skills.
- System design allows performance of voltage and signal measurements, alignment, calibration, and signal tracing.
- Coaxial cables eliminate radiation and noise interference.
- System can be wireless with the use of antennas in place of coaxial cable.
- Noise can be introduced to simulate atmospheric disturbances, and to provide realistic signal-to-noise evaluation.
- A Power Supply/Dual Audio Amplifier is the base of the complete system.

REQUIRED EQUIPMENT

Oscilloscope (not required with alternate system 8080-A0)

SYSTEM ENHANCEMENT

X-Y Recorder

SYSTEM VOLTAGES

120, 220, 240 V - 50/60 Hz

ESTIMATED PROGRAM HOURS

- Volume 1 30 hours
- Volume 2 50 hours
- Volume 3 60 hours

LANGUAGE VARIATIONS

English, Spanish, French

DIGITAL COMMUNICATIONS TRAINING SYSTEM MODEL 8085

The Lab-Volt Digital Communications Training System incorporates the latest IC technology with state-of-the-art signal modulators and demodulators to teach basic and advanced principles of digital communications.

The basic system contains 13 instructional modules supported by 16 instrumentation modules. The advanced system contains seven add-on modules: Baseband Channel/Brickwall Filter; Time-Division Multiplexer; Time-Division Demultiplexer; T1/CEPT PCM Transceiver; Clock Recovery; Line Coder; and Line Decoder.

Model 8085-B0, an alternate system, includes the LVDAM-COM software and interface, Model 9407, which replaces three of the six instrumentation modules (Frequency Counter, True RMS Voltmeter/Power Meter, and Spectrum Analyzer) of the standard system and an oscilloscope, with a set of computer-based instruments. See page 24 for additional information.

TOPIC COVERAGE

BASIC DIGITAL COMMUNICATIONS VOLUME 1, PULSE MODULATION AND SAMPLING

- Pulses
- Pulse Amplitude Modulation (PAM)
- Demodulating PAM Signals
- Pulse-Time Modulation (PWM/PPM)
- Demodulating PWM/PPM Signals
- Troubleshooting PAM/PWM/PPM Systems

VOLUME 2, DIGITAL MODULATION

- Analog-to-Digital and Digital-to-Analog Conversion
- Distortion and Quantization Noise
- Pulse Code Modulation (PCM)
- Differential Pulse Code Modulation (DPCM)
- Delta Modulation (DM)
- Troubleshooting Digital Communications Systems

VOLUME 3, MODEMS AND DATA TRANSMISSION

- Baseband Data Transmission
- Amplitude-Shift Keying (ASK)
- Frequency-Shift Keying (FSK)
- FSK Communications Standards
- Binary Phase-Shift Keying (BPSK)
- Troubleshooting Digital Communications Systems

ADVANCED DIGITAL COMMUNICATIONS BASEBAND DATA TRANSMISSION

- Principles of Time-Division Multiplexing and Demultiplexing
- T1 (PCM-24) and CEPT (PCM-30 Multiplexing)
- Clock Recovery
- Line Coding



FEATURES

- Latest IC technology and signal modulators/demodulators
- Easy access to test points and fault-insertion switches
- Safety shielding and full short-circuit protection
- Silk-screened block diagrams and component labels
- System enclosure eliminates power cable clutter.

REQUIRED EQUIPMENT

Oscilloscope (not required with alternate system 8085-B0)

SYSTEM ENHANCEMENTS

- Storage Cabinet
- FM/PM Receiver

SYSTEM VOLTAGES

120, 220, 240 V - 50/60 Hz

ESTIMATED PROGRAM HOURS

- | | |
|------------------------------|----------|
| ▪ Volume 1 | 50 hours |
| ▪ Volume 2 | 60 hours |
| ▪ Volume 3 | 50 hours |
| ▪ Baseband Data Transmission | 10 Hours |

LANGUAGE VARIATIONS

English, Spanish, French

LVSIM[®]-ACOM and LVSIM[®]-DCOM: Simulation and Virtual Instruments for Analog & Digital Communications

Realistic, Computer-Based Training Saves Time, Facilitates In-Lab Tasks, and Increases Student Motivation

In response to the need for more efficient and cost-effective training, Lab-Volt has developed a simulation approach to technical training that transfers training to the computer desktop until students have had enough practice to apply their skills on actual laboratory equipment. LVSIM-ACOM is specifically for analog communications, and LVSIM-DCOM is for digital communications. Both software programs:

- Enable students to set up the same equipment required for the Lab-Volt Analog Communications (Model 8080) or Digital Communications (Model 8085) Training System. Using the mouse, students manipulate realistic images of Lab-Volt equipment on the computer screen and make connections by dragging icons of virtual leads.
- Can be copied onto several personal computers so that students can become familiar with the equipment configuration before they enter the lab. In this way, the time spent on in-lab tasks is reduced by 50%, along with the need for physical hardware per student. With limited investment, institutions can now deliver high-standard training in both Analog and Digital Communications.
- Are bundled with the Lab-Volt Data Acquisition and Management System for telecommunications (LVDAM-COM) to further enable students to observe and accurately measure voltage, frequency, and RF power. LVDAM-COM also enables students to plot graphs and analyze waveforms and frequency spectra.
- Speed the learning process by eliminating the need to connect actual equipment. Virtual instrumentation also reduces the need for desktop and storage space for laboratory equipment.



Working in pairs or by themselves, students use LVSIM-ACOM and LVSIM-DCOM to gain a working knowledge of analog and digital communications systems before testing their skills on actual laboratory equipment.

Typical Equipment Setup in LVSIM[®]-ACOM

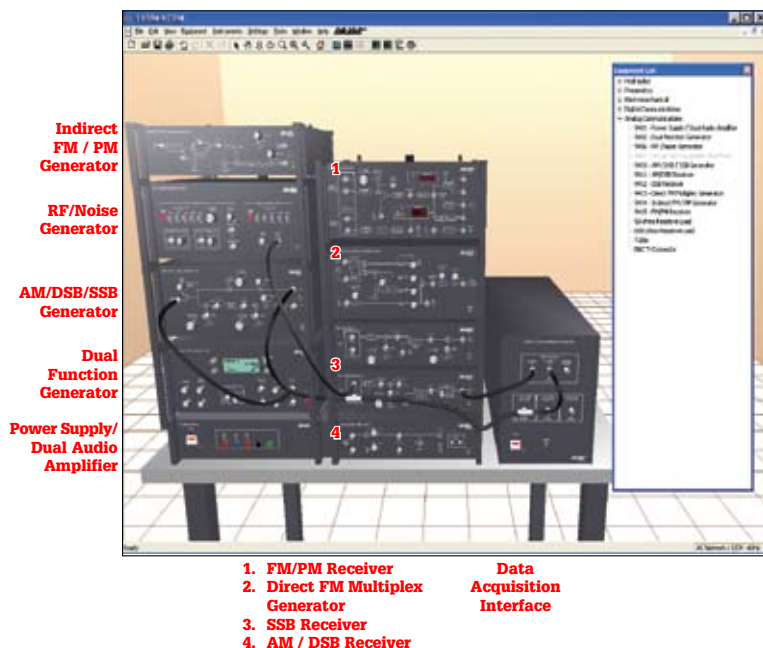

LVSIM®-ACOM VIRTUAL LABORATORY EQUIPMENT FOR ANALOG COMMUNICATIONS MODEL 9480

LVSIM-ACOM is a Windows-based simulation program that covers the same courseware associated with the Analog Communications Training System, Model 8080. With LVSIM-ACOM, all the standard Analog Communications laboratory equipment is replaced with three-dimension replicas of modules that students can manipulate on the computer screen. Using the mouse, students can identify and set up equipment for a given exercise, make the necessary connections between modules, and verify the connections made without ever touching a physical module.

LVSIM-ACOM comes bundled with Lab-Volt's Data Acquisition and Management for Telecommunications (LVDAM-COM) software, which enables students to perform voltage, frequency, and power measurements, as well as waveform analysis, in both the time and frequency domains. See page 26 for additional information.

TOPIC COVERAGE

- Basic Concepts and Equipment
- Spectral Analysis
- Modulation Fundamentals
- Amplitude Modulation (AM) Fundamentals
- The Generation of AM Signals
- Reception of AM Signals
- Double-Sideband (DSB) Modulation
- Single-Sideband (SSB) Modulation
- Frequency Modulation Concept
- Fundamentals of Frequency Modulation
- Narrowband Angle Modulation
- Wideband Frequency Modulation
- Generation of FM Signals
- Reception of FM Signals
- Frequency Division Multiplexing
- Noise in Frequency Modulation

SIMULATED EQUIPMENT

- Power Supply/Dual Audio Amplifier
- Dual Function Generator
- RF/Noise Generator
- Virtual Test Equipment Interface
- AM/DSB/SSB Generator
- AM/DSB Receiver
- SSB Receiver
- Direct FM Multiplex Generator
- Indirect FM/PM Generator
- FM/PM Receiver

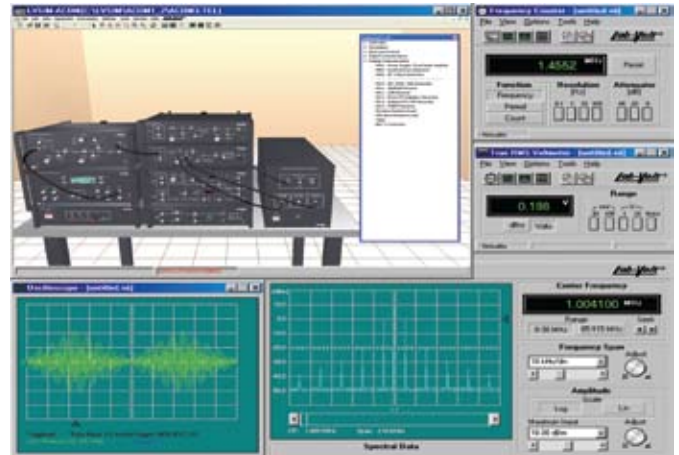

FEATURES

Special features of LVSIM-ACOM enable students to perform the following tasks from the desktop:

- Install, move, and remove modules
- Select colored wires to connect modules to each other
- Modify or remove connections at any time
- Change the color of wires
- Launch and run the LVDAM-COM application within LVSIM-ACOM
- Zoom in or out to adjust the view
- Apply virtual power to the equipment
- Generate AF/RF signals
- Perform measurements of voltage, frequency, and power with virtual digital meters
- Observe waveforms on a virtual oscilloscope
- Observe spectral information on a virtual spectrum analyzer
- Record measurements in a data table
- Plot graphs using recorded data
- Print display screens
- Save and restore environments (equipment setups), data and waveforms

MINIMUM COMPUTER REQUIREMENTS

A Pentium personal computer, running under one of the following Microsoft operating systems — Windows 98, Windows NT, Windows 2000, Windows XP, or Windows Me. A CD-ROM drive and a sound card are also required to use the Visual Tour multimedia tool.

SYSTEM VOLTAGES

120, 220, 240 V - 50/60 Hz

ESTIMATED PROGRAM HOURS

120 Hours

LANGUAGE VARIATIONS

English, Spanish, French

LVSIM®-DCOM VIRTUAL LABORATORY EQUIPMENT FOR DIGITAL COMMUNICATIONS MODEL 9481

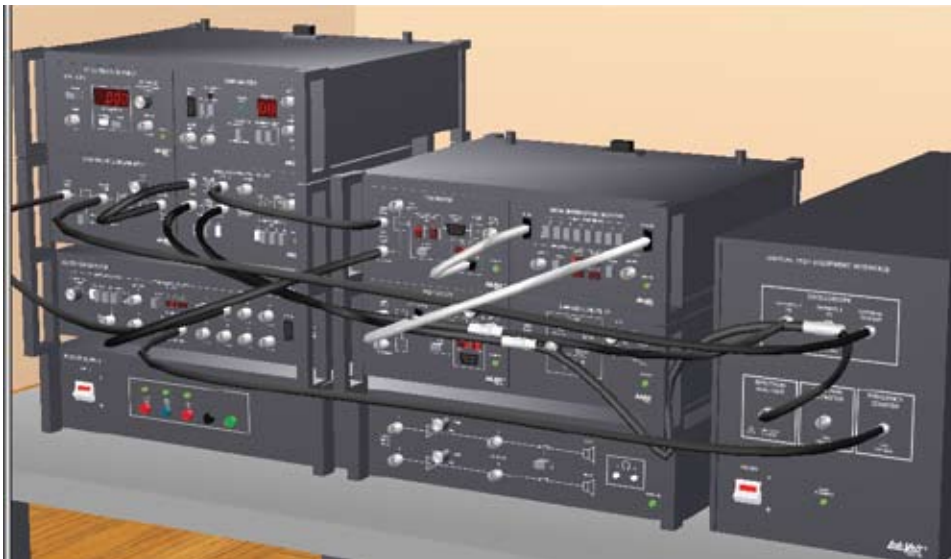

LVSIM-DCOM is a Windows-based simulation program that covers the same courseware as the Digital Communications Training System, Model 8085. LVSIM-DCOM recreates a three-dimensional classroom laboratory on a computer screen. The laboratory equipment of the Digital Communications Training System is replaced with three-dimensional replicas (images), which students can manipulate on the computer screen. Using the mouse, students can install virtual Digital Communications equipment in the laboratory, connect the equipment, perform a lab exercise, and obtain the same results as with the actual Lab-Volt training equipment. Sophisticated mathematical models accurately simulate the characteristics of the actual Digital Communications modules. All modules contained in the LVSIM-DCOM software feature the same functionality and appearance as the actual equipment.

LVSIM-DCOM comes bundled with Lab-Volt's Data Acquisition and Management for Telecommunications (LVDAM-COM) software, which enables students to perform voltage, frequency, and power measurements, as well as waveform analysis, in both the time and frequency domains. See page 26 for additional information.

TOPIC COVERAGE

- Pulses
- Pulse Amplitude Modulation (PAM)
- Demodulating PAM Signals
- Pulse-Time Modulation (PWM/PPM)
- Demodulating PWM/PPM Signals
- A/D and D/A Conversions
- Distortion and Quantization Noise
- Pulse Code Modulation (PCM)
- Differential Pulse Code Modulation (DPCM)
- Delta Modulation (DM)

- Baseband Data Transmission
- Amplitude-Shift Keying (ASK)
- Frequency-Shift Keying (FSK)
- FSK Communications Standards
- Binary Phase-Shift Keying (BPSK)

SIMULATED EQUIPMENT

- Power Supply/Dual Audio Amplifier
- Dual Function Generator
- RF/Noise Generator
- Virtual Test Equipment Interface
- Enclosure/Supply Regulator
- Clock Generator
- Pseudo-Random Binary Sequence Generator
- Bit Error Rate Indicator
- Logic Analyzer
- DC Voltmeter/DC Source
- Low Pass Audio Filter
- Synchronous Audio Generator
- Signal Interrupter/Selector
- Noise Measurement Filters
- PAM/ASK Generator
- PAM/ASK Receiver
- PWM/PPM Generator
- PWM/PPM Receiver
- PCM Encoder
- PCM Decoder
- DPCM Encoder
- DPCM Decoder
- FSK Modem
- BPSK Modulator
- BPSK Demodulator
- Delta/CVSD Encoder
- Delta/CVSD Decoder
- Cables and Accessories
- Table

FEATURES

Special features of LVSIM-DCOM enable students to perform the following tasks from the desktop:

- Install, move, rotate, and remove Digital Communications equipment.
- Connect Digital Communications components.
- Modify or remove Digital Communications component connections.
- Change the color of cables.
- Launch and run the LVDAM-COM application within LVSIM-DCOM.
- Zoom in or out to adjust the view.
- Apply virtual power to the equipment.
- Observe waveforms on a virtual oscilloscope.
- Observe spectral information on a virtual spectrum analyzer.
- Perform voltage and power measurements using a virtual true RMS voltmeter/power meter.
- Perform frequency measurements using a virtual frequency counter.
- Record measurements in a data table.
- Plot graphs using recorded data.
- Print display screens.
- Save and restore equipment setups, data, and waveforms.

MINIMUM COMPUTER REQUIREMENTS

A Pentium personal computer, running under one of the following Microsoft operating systems – Windows 98, Windows NT, Windows 2000, Windows XP, or Windows Me.

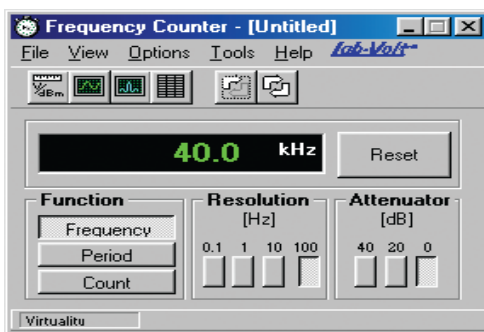

The Frequency Counter and the True-RMS Voltmeter/Power Meter in LVDAM-COM enable accurate measurements of frequency, voltages, and relative power levels.

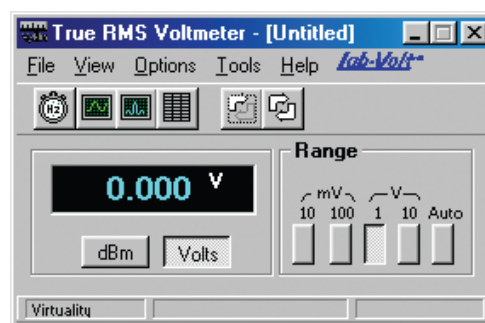

SYSTEM VOLTAGES

120, 220, 240 V - 50/60 Hz

ESTIMATED PROGRAM HOURS

140 Hours

LANGUAGE VARIATIONS

English, Spanish, French

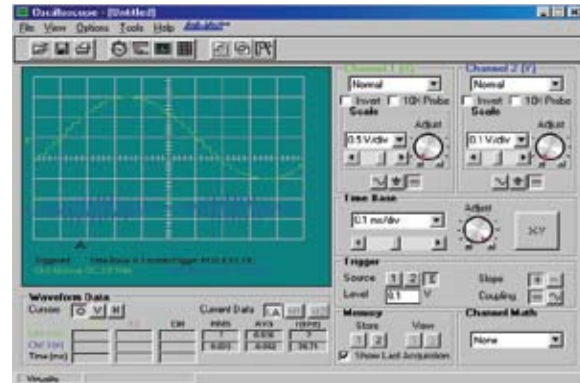

Quantization noise at the output of a PCM communication system implemented with the LVSIM-DCOM software, observed using the virtual oscilloscope.

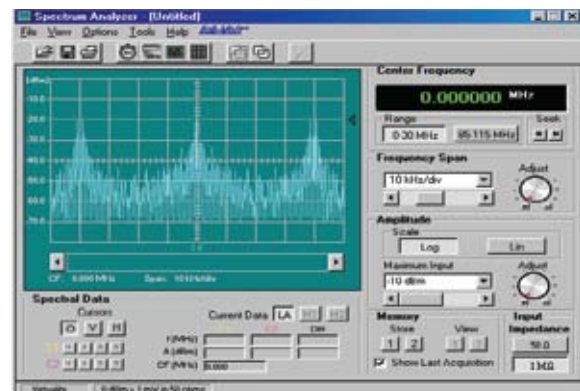

Quantization noise at the output of a PCM communication system implemented with the LVSIM-DCOM software, observed using the virtual spectrum analyzer.

LVDAM®-COM DATA ACQUISITION AND MANAGEMENT FOR TELECOMMUNICATIONS MODEL 9407



The Lab-Volt Data Acquisition and Management for Telecommunications (LVDAM-COM), Model 9407, is a computer-based system for measuring, observing, and analyzing signals in telecommunications systems. It allows training in both analog and digital telecommunications systems using modern and versatile measuring instruments.

The LVDAM-COM system consists of the LVDAM-COM software and the Virtual Test Equipment Interface (VTEI) module. It can replace the Lab-Volt conventional instruments (Frequency Counter, Model 9403, True-RMS Voltmeter/Power Meter, Model 9404, and Spectrum Analyzer, Model 9405) and an oscilloscope in the Analog Communications Training System, Model 8080, and Digital Communications Training System, Model 8085.

The VTEI module links the personal computer running the LVDAM-COM software with the Lab-Volt Analog and Digital Communications Training Systems. Data exchange between the VTEI module and the personal computer is made through a standard parallel port. The VTEI module is designed to meet the high-frequency signal requirements for telecommunications systems. It provides the necessary hardware to implement a dual-trace oscilloscope, a spectrum analyzer, a true-RMS voltmeter, and a frequency counter. All inputs are fitted with BNC connectors and are fully protected against short circuits and misconnections.

The LVDAM-COM software consists of a complete set of instruments that runs on an IBM®-compatible personal computer under the Microsoft Windows operating environment. Each instrument appears as a window on the computer screen.

The LVDAM-COM software can operate in either an Acquisition or Simulation mode. In the Acquisition mode, the input signals are measured by the VTEI module and then transmitted to the LVDAM-COM software through the computer's parallel port. In the Simulation mode, input signals are generated by the computer using user-defined

simulation parameters. When used in conjunction with simulation software, LVSIM-ACOM or LVSIM-DCOM, a third mode, referred to as Virtuality, is available. In this mode, input signals are generated by the computer using simulation parameters that are produced by the LVSIM-ACOM or LVSIM-DCOM software.

FEATURES

FREQUENCY COUNTER

- 10-Hz to 200-MHz frequency range
- Measures either the frequency or period of the input signal
- Can be used as an event counter
- Frequency resolution adjustable in decade steps from 0.1 to 100 Hz
- Three input signal attenuation settings (0 dB, 20 dB, and 40 dB)

TRUE-RMS VOLTMETER

- Measures voltage or relative power level of signals ranging from 50 Hz to 12 MHz
- Manual or automatic measuring range selection

SPECTRUM ANALYZER

- Two frequency ranges: 0 to 30 MHz and 85 to 115 MHz
- Selectable frequency span from 2 kHz/DIV to 1 MHz/DIV
- Window showing the spectrum of the overall frequency range selected
- Easy center-frequency setting using the keyboard or the "seek" function
- Linear or logarithmic vertical scales. Several vertical scale settings can be selected.
- Vertical and horizontal cursors for precise measurements at particular points on the displayed spectrum
- Two memories for saving displayed spectra

OSCILLOSCOPE

- Two channels
- 40-MHz bandwidth (20 MHz for second channel)
- External triggering input
- Vertical controls similar to those found on conventional oscilloscopes
- Automatic scale setting function allowing the sensitivity of each channel to be set automatically according to the magnitude of the observed parameter
- Time base and trigger controls similar to those found on most oscilloscopes to facilitate adjustment
- Vertical and horizontal cursors for precise measurements at particular points on the displayed waveforms
- Two memories for saving the displayed waveforms

SYSTEM VOLTAGES

- 120 V, 60 Hz
- 220 V, 50 Hz
- 240 V, 50 Hz

MINIMUM COMPUTER REQUIREMENTS

A Pentium personal computer, running under one of the following Microsoft operating systems -- Windows 98, Windows NT, Windows 2000, Windows XP, or Windows Me.

LANGUAGE VARIATIONS

English, Spanish, French

DATA TABLE AND GRAPH

- Data indicated by the various instruments can be recorded in the data table window.
- Recorded data can be used to plot graphs by selecting which parameter(s) to plot in the graph window, thereby allowing lab results to be plotted quickly and easily.
- Values recorded in the data table can be saved to a file.

The image displays the LVDAM-COM software interface, which simulates a laboratory environment. The main window shows a virtual rack of electronic equipment, including an oscilloscope, a signal generator, a frequency counter, and a true RMS voltmeter. Red dotted arrows point from the physical equipment in the main window to their respective software control windows. The oscilloscope window shows a waveform with various control knobs and a data table. The signal generator window shows a sine wave and various frequency and amplitude settings. The frequency counter window displays a reading of 4.811 kHz. The true RMS voltmeter window displays a reading of 2.095 V.

Using LVDAM-COM, students perform accurate measurements and become familiar with real electronic equipment and high-tech instrumentation.

TELEPHONY TRAINING SYSTEM MODEL 8086

The Lab-Volt Telephony Training System (TTS), Model 8086, is a powerful learning tool that provides training on modern telephone networks and digital private automatic branch exchanges (PABX). The TTS is built upon state-of-the-art, programmable equipment that operates real-world devices, including telephone sets and phone lines. The TTS courseware covers the following fields of telephony: analog access to the telephone network, central office operation, digital PABX, PABX analog trunk, and digital trunk.

The cornerstone of the TTS is the Reconfigurable Training Module, Model 9431. This module, which uses digital signal processor (DSP) technology, can be programmed to act as different parts of a telephone network, such as a digital central office (CO) of the public switched telephone network (PSTN) or a digital PABX. Analog and digital interface cards, which the students install in the training module, allow connection of real analog and digital telephone sets and trunk lines.

For example, a digital CO is easily implemented by inserting an analog line interface card into a training module programmed to act as a central office. Similarly, a digital PABX is implemented by inserting a digital telephone interface card into a training module programmed to act as a PABX. Furthermore, a simple telephone network, like the one shown in Figure 1, can be set up quickly by adding analog and digital trunk interface cards to two COs, and a PABX implemented with three training modules, and interconnecting the modules with trunk lines. Such a telephone network allows establishment of both intra- and inter-exchange calls, as well as tandem-switched calls.

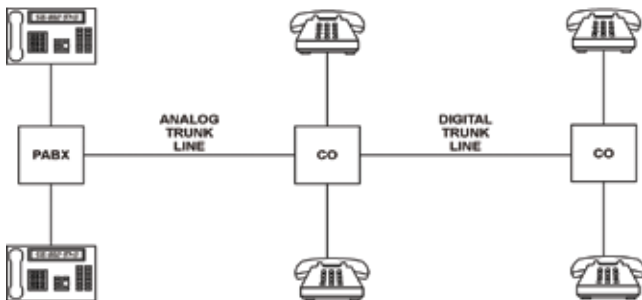

Fig. 1

Example of a simple telephone network

A Pentium-type host computer is required for connection to the training module through a high-speed data link (Ethernet link with TCP/IP protocol). The host computer is used to configure the training module as a digital CO or a digital PABX, using the included Lab-Volt Telephony Training System (LVTTS) software. This Windows-based software has an intuitive user interface that allows the following training activities:



*8086-1 Basic Telephony Training System
(Shown with computer, not included.)*

- Display the functional block diagram of the telephony equipment (CO, digital PABX, etc.) implemented in the Reconfigurable Training Module (see Figure 2).
- Change various system settings and options, such as the telephone ringing cadence, companding type, subscriber names and phone numbers, etc. (see Figure 3).
- Perform step-by-step observation of call-routing sequences.
- Observe real signals throughout the system in both the time and frequency domains using modern virtual instruments (see Figure 4).
- Insert faults in the system (password-protected feature) for troubleshooting purposes.

The Telephony Training System is also an essential tool to introduce students to the Integrated Services Digital Network (ISDN). This is due to the fact that the digital PABX which can be set up with the TTS uses digital telephone sets of the ISDN type and ISDN basic rate interfaces. Furthermore, the digital trunk that can be set up to interconnect two COs implemented with the TTS uses ISDN primary rate interfaces. Thus, while performing the courseware material for the digital PABX and the digital trunk, students are introduced to the following two major aspects of ISDN: the physical layer (layer 1) and the network layer (layer 3). A powerful data-logging instrument in the LVTTS software allows recording of all ISDN layer-3 messages exchanged between ISDN entities (call processor in a CO or PABX, digital telephone sets) during telephone calls. This instrument enables students to perform a thorough investigation of the ISDN signaling protocol.

TOPIC COVERAGE

VOLUME 1, ANALOG ACCESS TO THE TELEPHONE NETWORK

- The Telephone Set
- Telephone Ringing
- The Telephone Switch-Hook and Handset
- Tone Dialing
- Pulse Dialing
- The Line Interface
- Battery Feed Power Supply
- Hybrid Function
- Pulse Code Modulation
- Companding
- Time-Division Multiplexing
- Signaling and Supervision

VOLUME 2, CENTRAL OFFICE OPERATION

- Signaling Circuit
- Hook Status Signal Demultiplexing and Storage
- Dialed Number Detection
- Call Progress Tone and Ringing Signal Generation
- Digital Switching
- Time-Division Switching
- Space-Division Switching
- Two-Dimensional Switching
- System Control
- Call Processor Functions
- Intra-Exchange Call-Routing Sequence
- Central Office Configuration
- Supplementary Services
- Caller Identification

VOLUME 3, PRIVATE AUTOMATIC BRANCH EXCHANGE (PABX)

- Architecture and Basic Operation
- Architecture of a Digital PABX
- Telephone Set Portability
- Internal Call Establishment Procedure
- Call Progress Indication
- Call Functions
- Call Holding and Multiple Call Control
- Call Transfer
- Conference Calling
- Intercom (Broadcast Function)

VOLUME 4, PABX ANALOG TRUNK

- Familiarization with the Lab-Volt PABX Analog Trunk
- Analog Trunk Interface
- Call Routing Over a PABX Analog Trunk
- External Call Answering and Termination
- External Call Establishment (Overlap Sending Method)
- External Call Establishment (En-Bloc Sending Method)
- PABX Configuration
- Configuring the Lab-Volt PABX

VOLUME 5, DIGITAL TRUNK

- Multiplexing Format and Basic Operation
- Familiarization with the Lab-Volt Digital Trunk
- Digital Trunk Interface
- Alarm Indication
- Inter-Exchange Signaling
- Outgoing Inter-Exchange Call Routing Sequence
- Incoming Inter-Exchange Call Routing Sequence
- Multiple Inter-Exchange Call Control

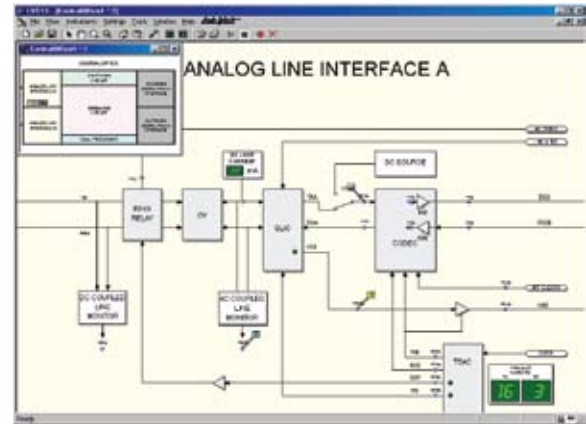

Fig. 2

Part of the functional block diagram of a CO as observed in the LVTTS software

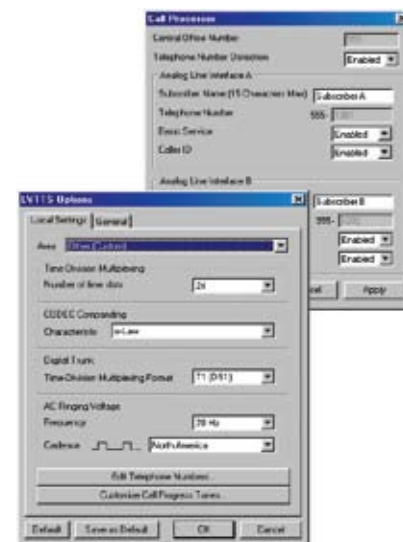

Fig. 3

System settings and options are configured through windows in the LVTTS software.

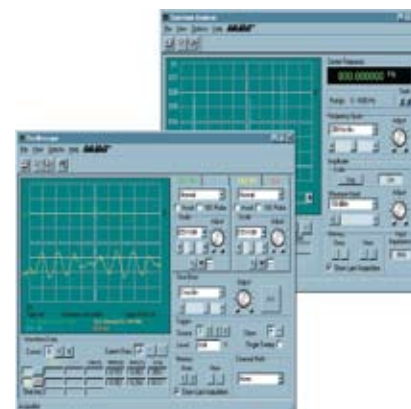

Fig. 4

Real signals can be observed in both the time and frequency domains using virtual instruments included with the LVTTS software.

FEATURES

- The Reconfigurable Training Module can be configured as a digital CO of the public switched telephone network (PSTN) or a digital PABX.
- A DSP executes downloaded programs and reads or produces external signals that are used to operate real-world devices (telephone sets, phone lines, etc.)
- Flexibility of software simulation plus realism of hardware operation
- Real-time, real-signal operation
- Provides real-life operation that is much more motivating than simple simulation
- Flexibility is enhanced by eliminating front panel controls and diagrams. These are all moved to a personal computer's screen.
- System can be configured for different international standards (e.g., telephone ringing cadence can be adjusted to each country's requirements).
- Reconfigurability prevents obsolescence of the system. As new standards and systems emerge, they need only be programmed and then downloaded into the training module.
- Simple interface cards designed to be installed into the training module allow connection of real analog and digital telephone sets and trunk lines.
- Analog telephone sets come with speakerphone, LCD display, tone/pulse switch, caller identification function, ringer on/off switch, multiple phone number memory, and one-touch call buttons.
- Digital telephone sets come with basic ISDN functions, programmable call appearance/function buttons, tiltable LCD display, and semi-duplex speakerphone.
- When configured as a digital PABX or when a digital trunk is set up, system allows study of the physical and network layers (layers 1 and 3 respectively) of ISDN.

SYSTEM VOLTAGES

120, 220, 240 Vac - 50/60 Hz

ESTIMATED PROGRAM HOURS

100 Hours

MINIMUM COMPUTER REQUIREMENTS

A Pentium personal computer, running under one of the following Microsoft operating systems: Windows 98, Windows NT, Windows 2000, Windows XP, or Windows Me is required to run the Lab-Volt Telephony Training System software. A PCI slot must be available in the computer for installation of an Ethernet adapter (network card) if none is available.



The Dual Analog Line Interface, Model 9475, is a simple interface card (module) to be installed in the reconfigurable Training Module, Model 9431. Two conventional telephone sets can be connected to this module.

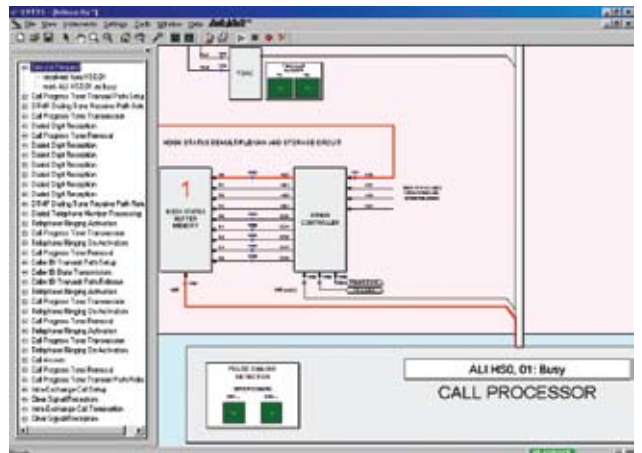

Actions performed by the central office (CO) call processor during a telephone call can be recorded and played back, thereby making the observation of call-routing sequences fast and easy.

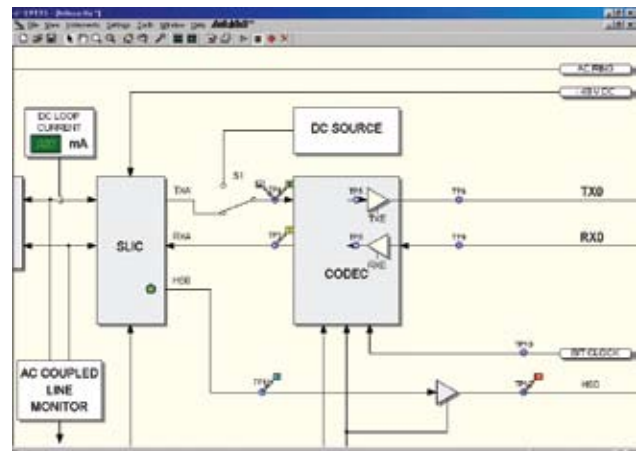

To observe real signals, virtual instrument probes are connected to test points in the functional block diagram displayed in the LVTTS software window.

MICROWAVE TECHNOLOGY TRAINING SYSTEM MODEL 8090

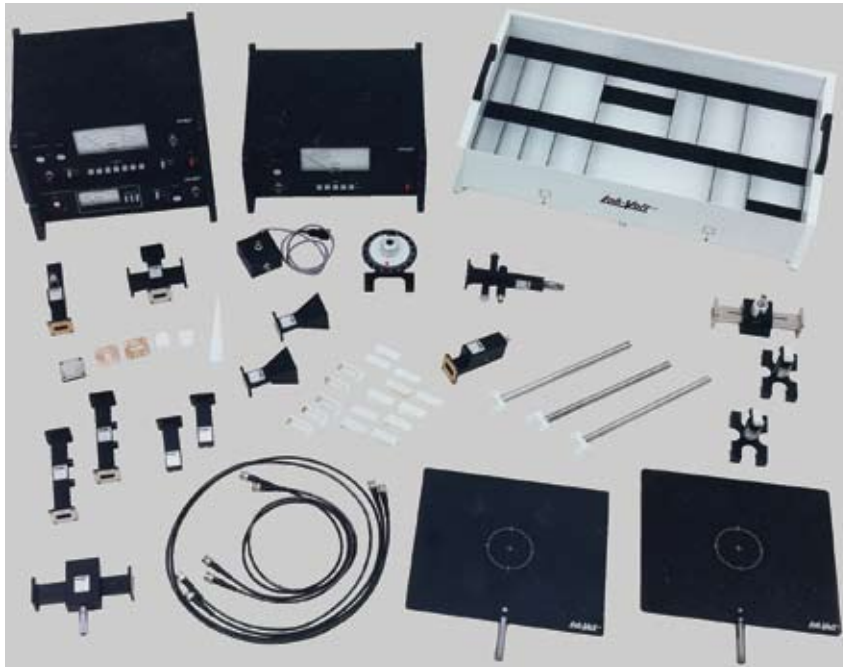

The Lab-Volt Microwave Technology Training System is a completely integrated package providing students with hands-on experimentation in the principles and practices of microwave technology.

With the exception of an oscilloscope, all power supplies, instrumentation, high-quality microwave components, student manuals, and accessories needed to perform experiments are included in the system.

TOPIC COVERAGE

- Familiarization with Microwave Equipment
- Power Measurements
- The Gunn Oscillator
- Calibration of the Variable Attenuator
- Detection of Microwave Signals
- Attenuation Measurements
- Standing Waves
- The Directional Coupler
- Reflection Coefficient Measurement
- SWR Measurements
- Impedance Measurements
- Reactive Impedances
- Impedance Matching
- Antennas and Propagation
- Microwave Optics

ENHANCED TOPIC COVERAGE

- Microwave frequency measurements
- Variable-frequency oscillators
- Frequency modulation and demodulation
- Data acquisition
- Construction and operation of PIN diodes
- Microwave switching

FEATURES

- Produces repeatable results
- Uses rugged, high-quality components designed for educational purposes
- Each component is identified with a standard microwave symbol and part number.
- Microwave devices and components are fabricated from electroless-plated brass to standard X-band waveguide dimensions.
- Waveguide flanges, joined by precision quick fasteners allow rapid assembly and disassembly of system configurations.

REQUIRED EQUIPMENT

Oscilloscope

SYSTEM ENHANCEMENTS

- Voltage Controlled RF Oscillator
- Resonant-Cavity Frequency Meter
- Hybrid Tee
- PIN Diode Modulator
- Video Amplifier
- PIN Diode/RF Oscillator Controller

SYSTEM VOLTAGES

120, 220, 240 V - 50/60 Hz

ESTIMATED PROGRAM HOURS

45 Hours

LANGUAGE VARIATIONS

English, Spanish, French

ANTENNA TRAINING AND MEASURING SYSTEM MODEL 8092



The Lab-Volt Antenna Training and Measuring System (ATMS) not only provides teachers and students with an innovative tool for hands-on experimentation on antennas in the 1-GHz and 10-GHz bands, but can also be used by design and research teams.

The ATMS includes sets of antennas, an RF generator, and a receiving system with a rotating antenna positioner, linked to a data acquisition interface. Also included with the system is a user-friendly software that operates under the Microsoft Windows environment.

The system is designed for low-power safe operation, both in the 1-GHz and 10-GHz bands (specifically at 915 MHz and at 10.5 GHz), allowing measurements of antenna characteristics (radiation pattern) in these bands. The data acquisition interface controls the antenna positioner and acquires the received antenna signal.

The system software provides a toolbox for controlling antenna rotation and data acquisition, as well as for displaying measured antenna characteristics in the E and H planes. It can combine the E and H plane characteristics to display tridimensional (3D) radiation patterns. The software also includes algorithms for estimating beamwidth and antenna gain from measured characteristics.

TOPIC COVERAGE

- Measurement of Radiation Pattern Parameters
- Measurement of Antenna Gain
- Experiments with Dipoles (1 GHz)
- Impedance Transformation with Baluns
- Directive Gain of Horn Antennas
- Monopole Antennas
- Loop Antenna (1 GHz)
- Circularly Polarized Antennas (10 GHz)
- Yagi Antennas
- Planar Patch Antennas
- Array Antennas
- Experiments with a 10-GHz Slot Antenna

- Parallel Fed 10-GHz Planar Antenna Array
- Series Fed 10-GHz Planar Antenna Array
- Multi-Beam Array Antenna (MBAA)
- MBAA Gain and Performance Evaluation
- MBAA Multi-Beam Operation

FEATURES

- Stand-alone system requires no other microwave equipment.
- System is compatible with the 10.5-GHz Lab-Volt Microwave Technology Training System (Model 8090).

1-GHz ANTENNAS

- Dipoles ($\lambda/2$, λ , $3\lambda/2$)
- Folded Dipole
- Folded Dipole with Balun
- Monopole $\lambda/4$
- Drooping Monopole
- Loops
- Yagi (fixed, adjustable)

10-GHz ANTENNAS

- Open Waveguide
- Slotted Waveguide
- Horns
- Array Antenna
- Serial Patch
- Parallel Patch
- Helicals

OPTIONAL EQUIPMENT

- Antenna Positioner
- Directional Coupler, 1 GHz
- Multi-Beam Array Antenna
- Parabolic Reflector
- Log-Periodic Antenna
- Two-Element Phasing Kit

SYSTEM VOLTAGES

120, 220, 240 V - 50/60 Hz

ESTIMATED PROGRAM HOURS

50 Hours

LANGUAGE VARIATIONS

English, Spanish, French

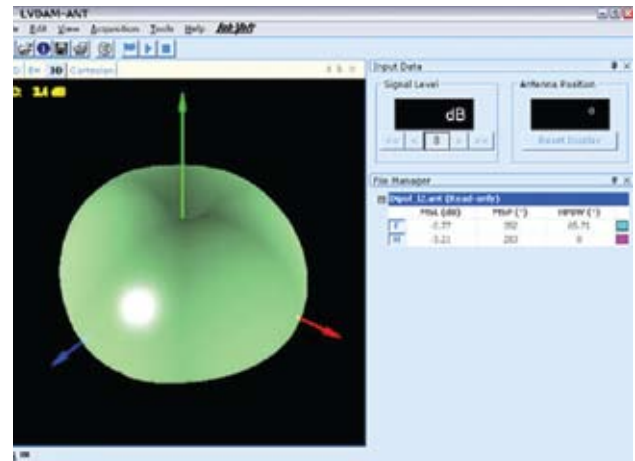

The E- and H-plane patterns can also be combined to produce a full 3D radiation pattern.

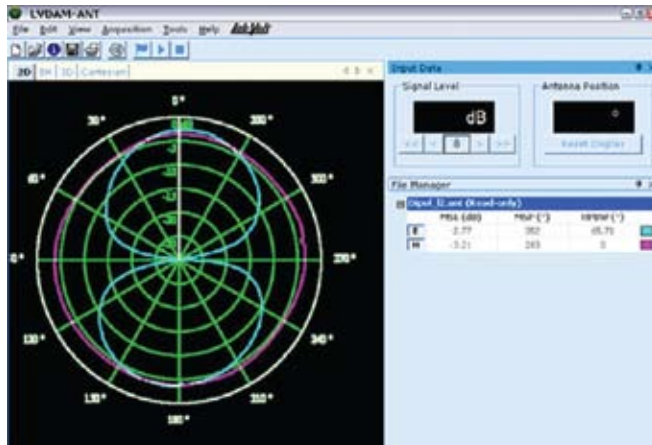

The E-plane and the H-plane are acquired separately. These patterns can be plotted on either polar or Cartesian graphs (shown above: polar coordinate graph; shown on right: Cartesian coordinate graph).

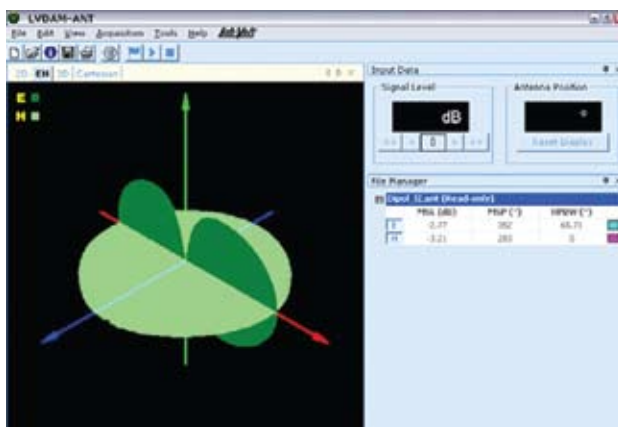
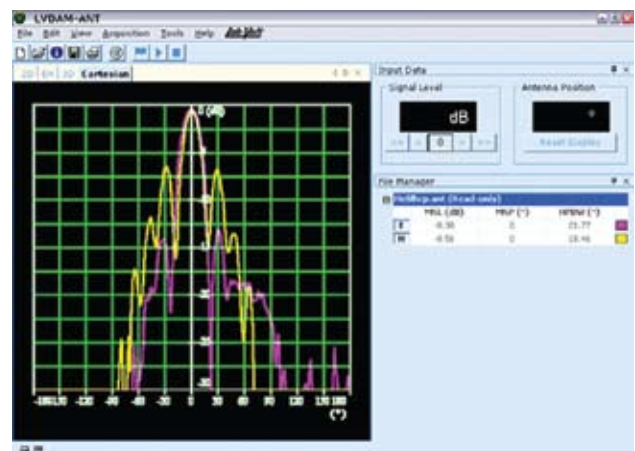

The acquired E- and H-plane patterns can be displayed simultaneously on a tridimensional (3D) display (shown above: dipole antenna pattern; shown right: helical antenna pattern).

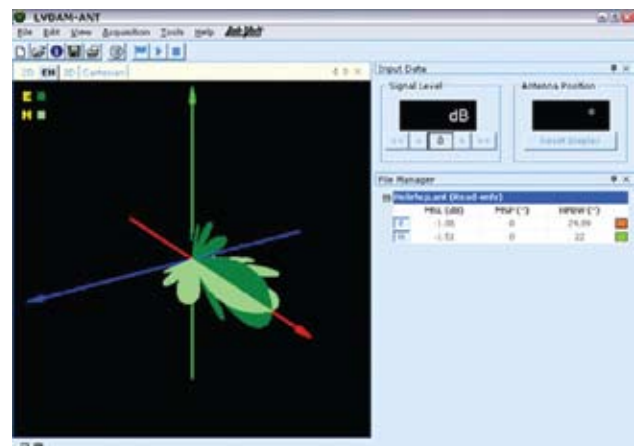

RADAR TRAINING SYSTEM MODEL 8096



The Lab-Volt Radar Training System consists of six subsystems (Models 8096-1 to 8096-6). Subsystems 8096-1 to 8096-3 provide students with hands-on training in the principles and operation of analog and digital radar, as well as radar tracking systems. Subsystem 8096-4 trains students in the principles and scenarios of Electronic Warfare (EW). Subsystem 8096-5 is a sophisticated, pulse-mode, radar cross-section (RCS) measurement training system, with inverse synthetic aperture radar (ISAR) imagery capability, that is designed for operation at close range. Subsystem 8096-6 provides students with training in the principles of electronically steered antennas. The Radar Training System uses patented technology to detect and track passive targets at very short range in the presence of noise, clutter, and interference. The very low transmitter power allows for safe operation in a variety of training environments.

The Basic Radar Training System, Model 8096-1 (shown above), is a complete set of hardware, courseware, and all necessary accessories, such as targets and interconnecting cables, that allows the principles of pulse, CW Doppler, and FM-CW radar systems to be studied. An oscilloscope is required for target echo visualization on an A-scope display as well as time-domain observation of signals at outputs and test points.

The Radar Processor/Display, Model 8096-2, is used in conjunction with the Basic Radar Training System, Model 8096-1, to form a complete, modern pulse radar system. The Radar Processor/Display adds the following elements: radar echo signal processing functions, PPI display functions, on-screen block diagrams of the complete radar and radar processor/display subsystem, and computer-based instructions. The Radar Processor/Display consists of a reconfigurable training module (RTM), a power supply



The Radar Processor/Display (Model 8096-2) provides all the equipment required to convert the Basic Radar Training System (Model 8096-1) into a modern pulse radar training system.

for the RTM, three interface modules, a set of accessories including the Lab-Volt Radar Training System (LVRTS) software, two comprehensive student manuals, and a user guide. A Pentium-type host computer (to be purchased separately) is required with the RTM.

The Radar Tracking Training System, Model 8096-3, adds on to the pulse radar implemented with the Basic Radar Training System and the Radar Processor/Display (Models 8096-1 and 8096-2, respectively), to form a continuous tracking radar. This radar can track a passive target that moves in the classroom laboratory. The Radar Tracking Training System includes an interface module to be installed in the RTM of the Radar Processor/Display, a special dual-feed parabolic antenna, a joystick-type hand controller, a set of accessories, and a student manual.



The Radar Tracking Training System (Model 8096-3) contains all equipment required to set up a continuous tracking radar.

The Radar Active Target (RAT) Training System, Model 8096-4, is used in conjunction with the three previous subsystems (Models 8096-1, 8096-2, and 8096-3) to train students in the principles and scenarios of Electronic Warfare (EW). This is a truly unique system that places real-time, safe, and unclassified EW demonstrations into the hands of students. The RAT Training System consists of an active jamming pod trainer, an elaborate set of accessories, and a comprehensive student manual.

The jamming pod is a Self-Screening Jammer (SSJ) target that can perform both direct and modulated noise jamming, as well as repeater jamming. It includes a remote controller to select the type of jamming and adjust the jamming parameters. The jamming pod trainer and the included accessories are designed for use with the Lab-Volt tracking radar to implement real EW situations. This provides an effective means of introducing students to a real-time jamming situation that necessitates a response, that is, the use of an appropriate electronic counter-countermeasure (ECCM) to prevent losing track of the target.



The active jamming pod and accessories in the RAT Training System enable realistic EW demonstrations to take place in a classroom laboratory.



The active jamming pod and its remote controller are the cornerstone of the RAT Training System.

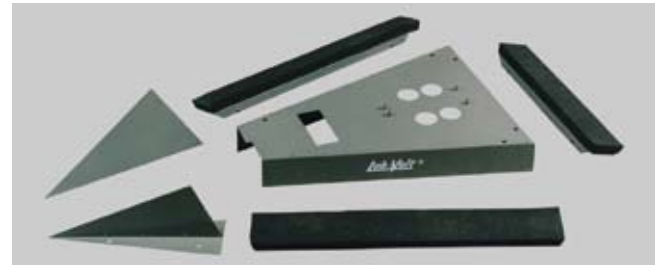

Stealth accessories in the RAT Training System allow reduction of the jamming pod trainer's radar cross section.



Antenna replacement is quick and easy thanks to miniature plug-in connectors in the antenna frame and pedestal's shaft.

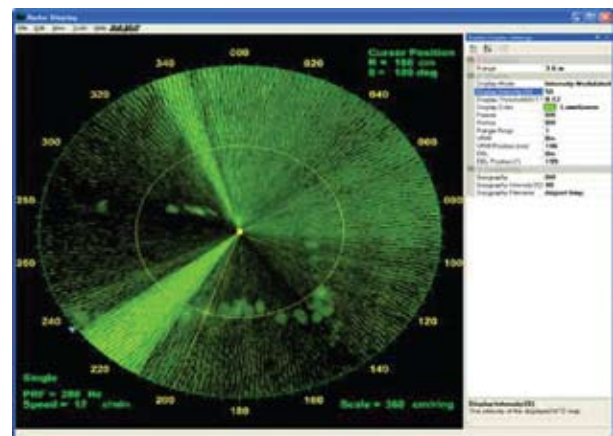

Effect of barrage noise jamming produced by the jamming pod trainer of the RAT Training System as observed on the Lab-Volt radar PPI display.



The RCS pattern of an actual aircraft can be obtained by placing a reflective scale model on top of the low-RCS rotating support of the RCS and ISAR Measurement Training System.

The RCS and ISAR Measurement Training System, Model 8096-5, adds on to the Basic Radar Training System, Model 8096-1, to form a computer-based, pulse-mode system that can measure the radar cross section (RCS) of targets as well as produce ISAR images of targets.

The system can generate RCS patterns of targets of up to 75-cm length when the longest pulse width is used. The system can also generate high-resolution ISAR images of much larger targets when the shortest pulse width is used. Because the system is based on pulse operation, it does not need to be operated in an anechoic chamber or in an outdoor range. Background clutter is rejected using time-gating and subtraction techniques during the measurement process.

The RCS and ISAR Measurement Training System includes a low-RCS target support to achieve precise RCS measurements; a high-quality desktop computer equipped with the necessary interface cards and RCS measurement/ISAR imagery software; an RCS/ISAR measurement interface module; a set of accessories, and a system user guide.

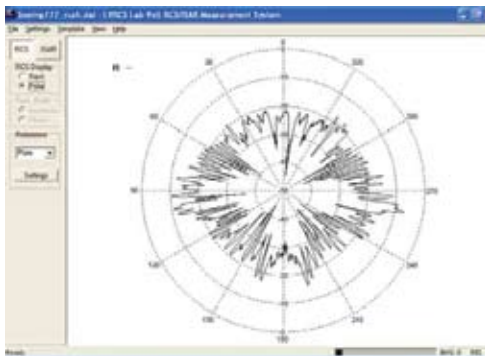

RCS pattern of a scale model of a Boeing 777 aircraft obtained using the RCS and ISAR Measurement Training System.

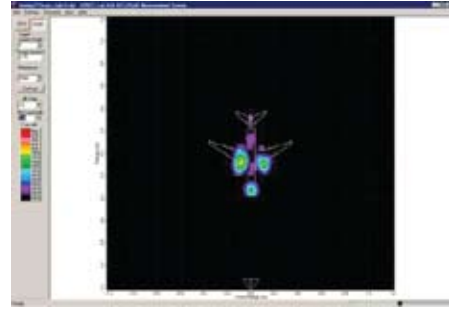

In the ISAR imagery mode, the RCS and ISAR Measurement Training System can produce images that show the shape of a target (top front view of a 777 Boeing aircraft shown).

The Radar Phased Array Antenna Trainer, Model 8096-6, is specifically designed to be used with the complete pulse radar system that can be implemented with the Basic Radar Training System and the Radar Processor/Display (Models 8096-1 and 8096-2). The trainer includes a phased array antenna, a beam-steering control module, the necessary cables, and a comprehensive student manual.



The Radar Phased Array Antenna Trainer, Model 8096-6

Beam steering in the Radar Phased-Array Antenna Trainer is achieved through a microwave switch coupled to a Rotman lens and microstrip tapered slot array (TSA) antennas. Beam steering control can be manual, continuous or radar Pulse Repetition Frequency dependent (PRF locked). Scan speeds of up to 1080 scans/min can be achieved. This allows the PPI display (sector scan) of the radar training system to be refreshed at much higher rates than with the conventional mechanically rotated parabolic antenna. Targets can thus be followed in near real time.



The Radar Phased-Array Antenna Trainer is fully compatible with the Lab-Volt radar training system. It allows sector-scan operation with no antenna motion.

TOPIC COVERAGE**Volume 1, Principles of Radar Systems**

- Basic Principles of Pulsed Radar
- The Range-Delay Relationship
- Radar Antennas
- The Radar Equation
- Radar Transmitter and Receiver
- Antenna Driving System
- CW Radar and the Doppler Effect
- Frequency-Modulated CW Radar
- Troubleshooting a CW Radar
- Troubleshooting an FM-CW Radar
- Troubleshooting a Pulsed Radar: The RF Section

Volume 2, Analog MTI Processing

- Familiarization with the Analog Pulse Radar
- The PPI Display
- Phase-Processing MTI
- Vector-Processing MTI
- Staggered PRF
- MTI Limitations
- Threshold Detection
- Pulse Integration
- Sensitivity Time Control
- Instantaneous Automatic Gain Control
- The Log-FTC Receiver
- Constant-False Alarm Rate
- Troubleshooting the MTI Processor
- Troubleshooting the Display Processor
- Troubleshooting the MTI Radar System

Volume 3, Digital MTD Processing

- Familiarization with the Digital Pulse Radar
- The PPI Display
- Cell Mapping
- Fast Fourier Transform (FFT) Processing
- Constant False-Alarm Rate (CFAR)
- Correlation and Interpolation (C&I) Processing
- Surveillance (Track-While-Scan) Processing
- Troubleshooting the Digital MTD/PPI Processor

Volume 4, Tracking Radar

- Manual Tracking of a Target
- Automatic Range Tracking
- Angle Tracking Techniques
- Automatic Angle Tracking
- Range and Angle Tracking Performance (Radar-Dependent Errors)
- Range and Angle Tracking Performance (Target-Caused Errors)
- Troubleshooting an Analog Target Tracker

Volume 5, Radar in an Active Target Environment

- Familiarization with the Radar Jamming Pod
- Spot Noise Jamming and Burn-Through Range
- Frequency Agility and Barrage Noise Jamming
- Video Integration and Track-On Jamming (TOJ)
- Antennas in EW: Sidelobe Jamming and Space Discrimination
- Deception Jamming using the Radar Jamming Pod
- Range Gate Pull-Off (RGPO)
- Stealth Technology: The Quest for Reduced RCS
- Deceptive Jamming Using Amplitude-Modulated Signals
- Cross-Polarization Jamming
- Multiple-Source Jamming Techniques
- Chaff Clouds
- Chaff Clouds Used as Decoys

Volume 6, The Radar Phased-Array Antenna

- Basic Principles, Operation and Adjustments
- The True Time-Delay Rotman Lens
- The Switching Matrix
- Beamwidth Measurement
- Radiation Pattern Measurement
- Angular Separation Measurement
- Phased Array Antenna Gain Measurement
- Maximum Scan Angle Measurement
- Target Bearing Estimation
- Target Speed Estimation

FEATURES

- Active, real-time radar system operating in a classroom laboratory
- Low power, safe operation
- Latest technology, e.g., microstrips, surface-mounted devices (SMDs), digital signal processing (DSP) and fast Fourier transform (FFT)
- Pulsed, continuous wave Doppler, and frequency-modulated continuous wave (FM-CW) modes of operation
- A-scope and plan position indicator (PPI raster and vector scan) display outputs
- Sensitive moving target detection (MTD) processor that differentiates between fixed and slowly moving targets at short range
- Surveillance processor for track-while-scan (TWS) operation
- Split range-gate tracker
- Leading-edge range tracker
- Lobe-switching angle tracker
- O-scope display output

REQUIRED EQUIPMENT

Oscilloscope (2)
Digital Multimeter
Function Generator
Frequency Counter
True-RMS Voltmeter/Power Meter

SYSTEM VOLTAGES

120, 220, 240 V - 50/60 Hz

ESTIMATED PROGRAM HOURS

- Volume 1 50 Hours
- Volume 2 60 Hours
- Volume 3 25 Hours
- Volume 4 20 Hours
- Volume 5 40 Hours
- Volume 6 20 Hours

LANGUAGE VARIATIONS

English, Spanish, French

Courseware Ordering Information

CBL = Computer-Based Learning

N/A = Not Available at time of printing

MODEL DESCRIPTION	120 V - 60 Hz			220 V - 50 Hz			240 V - 50 Hz
	ENGLISH	FRENCH	SPANISH	ENGLISH	FRENCH	SPANISH	ENGLISH
91018 FACET® ANALOG COMMUNICATIONS							
Student Manual	90877-00	90877-01	N/A	90877-00	90877-01	N/A	90877-00
CBL Student Workbook	91578-00	N/A	N/A	91578-00	N/A	N/A	91578-00
Instructor Guide	90877-10	N/A	N/A	90877-10	N/A	N/A	90877-10
CBL Instructor Guide	91578-10	N/A	N/A	91578-10	N/A	N/A	91578-10
Pre-test	90877-40	N/A	N/A	90877-40	N/A	N/A	90877-40
Pre-test Answer Key	90877-50	N/A	N/A	90877-50	N/A	N/A	90877-50
Post-test	90877-60	N/A	N/A	90877-60	N/A	N/A	90877-60
Post-test Answer Key	90877-70	N/A	N/A	90877-70	N/A	N/A	90877-70
Software	91018-W0	N/A	N/A	91018-W0	N/A	N/A	91018-W0
91022 FACET® DIGITAL COMMUNICATIONS 1							
Student Manual	91733-00	N/A	91733-02	91733-00	N/A	91733-02	91733-00
CBL Student Workbook	91581-00	N/A	N/A	91581-00	N/A	N/A	91581-00
Instructor Guide	91733-10	N/A	91733-12	91733-10	N/A	91733-12	91733-10
CBL Instructor Guide	91581-10	N/A	N/A	91581-10	N/A	N/A	91581-10
Pre-test	91733-40	N/A	N/A	91733-40	N/A	N/A	91733-40
Pre-test Answer Key	91733-50	N/A	N/A	91733-50	N/A	N/A	91733-50
Post-test	91733-60	N/A	N/A	91733-60	N/A	N/A	91733-60
Post-test Answer Key	91733-70	N/A	N/A	91733-70	N/A	N/A	91733-70
Software	91022-W0	N/A	N/A	91022-W0	N/A	N/A	91022-W0
91023 FACET® DIGITAL COMMUNICATIONS 2							
Student Manual	91739-00	N/A	91739-02	91739-00	N/A	91739-02	91739-00
CBL Student Workbook	91582-00	N/A	N/A	91582-00	N/A	N/A	91582-00
Instructor Guide	91739-10	N/A	91739-12	91739-10	N/A	91739-12	91739-10
CBL Instructor Guide	91582-10	N/A	N/A	91582-10	N/A	N/A	91582-10
Pre-test	91739-40	N/A	N/A	91739-40	N/A	N/A	91739-40
Pre-test Answer Key	91739-50	N/A	N/A	91739-50	N/A	N/A	91739-50
Post-test	91739-60	N/A	N/A	91739-60	N/A	N/A	91739-60
Post-test Answer Key	91739-70	N/A	N/A	91739-70	N/A	N/A	91739-70
Software	91023-W0	N/A	N/A	91023-W0	N/A	N/A	91023-W0
91025 FACET® FIBER OPTIC COMMUNICATIONS							
Student Manual	91967-00	91967-01	N/A	91967-00	91967-01	N/A	91967-00
CBL Student Workbook	91584-00	N/A	N/A	91584-00	N/A	N/A	91584-00
Instructor Guide	91967-10	N/A	N/A	91967-10	N/A	N/A	91967-10
CBL Instructor Guide	91584-10	N/A	N/A	91584-10	N/A	N/A	91584-10
Pre-test	91967-40	N/A	N/A	91967-40	N/A	N/A	91967-40
Pre-test Answer Key	91967-50	N/A	N/A	91967-50	N/A	N/A	91967-50
Post-test	91967-60	N/A	N/A	91967-60	N/A	N/A	91967-60
Post-test Answer Key	91967-70	N/A	N/A	91967-70	N/A	N/A	91967-70
Software	91025-W0	N/A	N/A	91025-W0	N/A	N/A	91025-W0
91027 FACET® DIGITAL SIGNAL PROCESSOR							
Student Manual	31946-00	31946-01	31946-02	31946-00	31946-01	31946-02	31946-00
CBL Student Workbook	31946-J0	N/A	31946-J2	31946-J0	N/A	31946-J2	31946-J0
Instructor Guide	31946-10	N/A	31946-12	31946-10	N/A	31946-12	31946-10
CBL Instructor Guide	31946-L0	N/A	31946-L2	31946-L0	N/A	31946-L2	31946-L0
Software	91027-W0	91027-W1	91027-W2	91027-W0	91027-W1	91027-W2	91027-W0
91028 FACET® TRANSMISSION LINES							
Student Manual	36970-00	N/A	N/A	36970-00	N/A	N/A	36970-00
CBL Student Workbook	36970-J0	N/A	N/A	36970-J0	N/A	N/A	36970-J0
Instructor Guide	36970-10	N/A	N/A	36970-10	N/A	N/A	36970-10
CBL Instructor Guide	36970-L0	N/A	N/A	36970-L0	N/A	N/A	36970-L0
Software	91028-W0	N/A	N/A	91028-W0	N/A	N/A	91028-W0
91029 FACET® QPSK/OQPSK/DPSK							
Student Manual	39158-00	N/A	N/A	39158-00	N/A	N/A	39158-00
CBL Student Workbook	39158-J0	N/A	N/A	39158-J0	N/A	N/A	39158-J0
Instructor Guide	39158-10	N/A	N/A	39158-10	N/A	N/A	39158-10
CBL Instructor Guide	39158-L0	N/A	N/A	39158-L0	N/A	N/A	39158-L0
Software	39158-W0	N/A	N/A	39158-W0	N/A	N/A	39158-W0

MODEL DESCRIPTION	120 V - 60 HZ			220 V - 50 HZ			240 V - 50 HZ
	ENGLISH	FRENCH	SPANISH	ENGLISH	FRENCH	SPANISH	ENGLISH
9407 LVDAM®-COM							
LVDAM®-COM User Guide	31498-E0	N/A	31498-E2	31498-E0	N/A	31498-E2	31498-E0
Virtual Test Equipment Interface Instruction Manual	31559-D0	N/A	31559-D2 N/A	31559-D0	N/A	31559-D2	31559-D0
Computer-Based Instrument User Guide	36220-E0	36220-E1	36220-E2	36220-E0	36220-E1	36220-E2	36220-E0
9480 LVSIM®-ACOM							
Instrumentation	26866-00	26866-01	26866-02	26866-00	26866-01	26866-02	26866-00
AM/DSB/SSB	26867-00	26867-01	26867-02	26867-00	26867-01	26867-02	26867-00
Instructor Guide	26866-10	26866-11	26866-12	26866-10	26866-11	26866-12	26866-10
FM/PM	26868-00	26868-01	26868-02	26868-00	26868-01	26868-02	26868-00
LVSIM® User Guide	32359-E0	32359-E1	32359-E2	32359-E0	32359-E1	32359-E2	32359-E0
Computer-Based Instrument User Guide	36220-E0	36220-E1	36220-E2	36220-E0	36220-E1	36220-E2	36220-E0
8080 ANALOG COMMUNICATIONS							
Student Manuals:							
Instrumentation	26866-00	26866-01	26866-02	26866-00	26866-01	26866-02	26866-00
AM/DSB/SSB	26867-00	26867-01	26867-02	26867-00	26867-01	26867-02	26867-00
FM/PM	26868-00	26868-01	26868-02	26868-00	26868-01	26868-02	26868-00
Instructor Guide	26866-10	26866-11	26866-12	26866-10	26866-11	26866-12	26866-10
9481 LVSIM®-DCOM							
Student Manuals:							
Pulse Modulation and Sampling	27695-00	27695-01	27695-02	27695-00	27695-01	27695-02	27695-00
Digital Modulation	27696-00	27696-01	27696-02	27696-00	27696-01	27696-02	27696-00
Modems and Data Transmission	27697-00	27697-01	27697-02	27697-00	27697-01	27697-02	27697-00
Instructor Guide	27695-10	27695-11	27695-12	27695-10	27695-11	27695-12	27695-10
LVSIM User Guide	32359-E0	32359-E1	32359-E2	32359-E0	32359-E1	32359-E2	32359-E0
Computer-Based Instrument User Guide	36220-E0	36220-E1	36220-E2	36220-E0	36220-E1	36220-E2	36220-E0
8085 DIGITAL COMMUNICATIONS							
Student Manuals:							
Pulse Modulation and Sampling	27695-00	27695-01	27695-02	27695-00	27695-01	27695-02	27695-00
Baseband Digital Modulation	27696-00	27696-01	27696-02	27696-00	27696-01	27696-02	27696-00
Modems and Data Transmission	27697-00	27697-01	27697-02	27697-00	27697-01	27697-02	27697-00
Instructor Guide	27695-10	27695-11	27695-12	27695-10	27695-11	27695-12	27695-10
8086 TELEPHONY							
Student Manuals:							
Analog Access to Telephone Network	32964-00	32964-01	32964-02	32964-00	32964-01	32964-02	32964-00
Central Office Operation	33646-00	33646-01	33646-02	33646-00	33646-01	33646-02	33646-00
Private Automatic Branch Exchange	33647-00	33647-01	33647-02	33647-00	33647-01	33647-02	33647-00
PABX Analog Trunk	35611-00	35611-01	35611-02	35611-00	35611-01	35611-02	35611-00
Digital Trunk	35815-00	35815-01	35815-02	35815-00	35815-01	35815-02	35815-00
Instructor Guide:							
Analog Access to Telephone Network	32964-10	32964-11	32964-12	32964-10	32964-11	32964-12	32964-10
Central Office Operation	33646-10	33646-11	33646-12	33646-10	33646-11	33646-12	33646-10
Private Automatic Branch Exchange	33647-10	33647-11	33647-12	33647-10	33647-11	33647-12	33647-10
PABX Analog Trunk	35611-10	35611-11	35611-12	35611-10	35611-11	35611-12	35611-10
Digital Trunk	35815-10	35815-11	35815-12	35815-10	35815-11	35815-12	35815-10
User Guide:							
Telephony Training System	32964-E0	32964-E1	32964-E2	32964-E0	32964-E1	32964-E2	32964-E0
8087 COMMUNICATIONS TECHNOLOGIES TRAINING SYSTEM							
LVCT Software	9432-00	9432-00	9432-00	9432-00	9432-00	9432-00	9432-00
Student Manuals:							
PAM/PWM/PPM Applications	39862-00	39862-01	39862-02	39862-00	39862-01	39862-02	39862-00
PCM/DPCM/Delta Modulation Applications	39863-00	39863-01	39863-02	39863-00	39863-01	39863-02	39863-00
ASK/FSK/BPSK Applications	39864-00	39864-01	39864-02	39864-00	39864-01	39864-02	39864-00
Quadrature Phase Shift Keying	39865-00	39865-01	39865-02	39865-00	39865-01	39865-02	39865-00
Quadrature Amplitude Modulation	39866-00	39866-01	39866-02	39866-00	39866-01	39866-02	39866-00
Asymmetric Digital Subscriber Line	39867-00	39867-01	39867-02	39867-00	39867-01	39867-02	39867-00
Code Division Multiple Access	N/A	N/A	N/A	N/A	N/A	N/A	N/A
Instructor Guide:							
PAM/PWM/PPM Applications	39862-10	39862-11	39862-12	39862-10	39862-11	39862-12	39862-10
PCM/DPCM/Delta Modulation Applications	39863-10	39863-11	39863-12	39863-10	39863-11	39863-12	39863-10
ASK/FSK/BPSK Applications	39864-10	39864-11	39864-12	39864-10	39864-11	39864-12	39864-10
Quadrature Phase Shift Keying	39865-10	39865-11	39865-12	39865-10	39865-11	39865-12	39865-10

MODEL DESCRIPTION	120 V - 60 HZ			220 V - 50 HZ			240 V - 50 HZ
	ENGLISH	FRENCH	SPANISH	ENGLISH	FRENCH	SPANISH	ENGLISH

8087 COMMUNICATIONS TECHNOLOGIES TRAINING SYSTEM

Quadrature Amplitude Modulation	39866-10	39866-11	39866-12	39866-10	39866-11	39866-12	39866-10
Asymmetric Digital Subscriber Line	39867-10	39867-11	39867-12	39867-10	39867-11	39867-12	39867-10
Code Division Multiple Access	N/A	N/A	N/A	N/A	N/A	N/A	N/A
CTTS User Guide	39862-E0	39862-E1	39862-E2	39862-E0	39862-E1	39862-E2	39862-E0
QAM Quick Start Guide	39866-P0	39866-P1	39866-P2	39866-P0	39866-P1	39866-P2	39866-P0
ADSL Quick Start Guide	39867-P0	39867-P1	39867-P2	39867-P0	39867-P1	39867-P2	39867-P0

8090 MICROWAVE TECHNOLOGY TRAINING SYSTEM

Student Manual: Introduction to Microwave Technology	28113-00	28113-01	28113-02	28113-00	28113-01	28113-02	28113-00
Microwave Variable-Frequency Measurements and Applications	39974	N/A	N/A	39974	N/A	N/A	39974
Microwave Tees, PIN Diodes and Applications	39975	N/A	N/A	39975	N/A	N/A	39975
Student Manual (Optional): Microwave Transmission Demonstration	28500-00	N/A	N/A	28500-00	N/A	N/A	28500-00
Instructor Guide: Microwave Technology	28113-10	28113-11	28113-12	28113-10	28113-11	28113-12	28113-10
Microwave Variable-Frequency Measurements and Applications	39974-10	N/A	N/A	39974-10	N/A	N/A	39974-10
Microwave Tees, PIN Diodes and Applications	39975-10	N/A	N/A	39975-10	N/A	N/A	39975-10

8092 ANTENNA TRAINING AND MEASURING SYSTEM

Student Manual	30857-00	30857-01	30857-02	30857-00	30857-01	30857-02	30857-00
Instructor Guide	30857-10	30857-11	30857-12	30857-10	30857-11	30857-12	30857-10
User Guide	30857-E0	30857-E1	30857-E2	30857-E0	30857-E1	30857-E2	30857-E0

8095 RADAR TRAINING SYSTEM

Student Manuals: Principles of Radar Systems	38542-00	38542-01	38542-02	38542-00	38542-01	38542-02	38542-00
Analog MTI Processing	38543-00	38543-01	38543-02	38543-00	38543-01	38543-02	38543-00
Digital MTD Processing	38544-00	38544-01	38544-02	38544-00	38544-01	38544-02	38544-00
Tracking Radar	38545-00	38545-01	38545-02	38545-00	38545-01	38545-02	38545-00
Radar in an Active Target Environment	38546-00	38546-01	38546-02	38546-00	38546-01	38546-02	38546-00
The Phased Array Antenna	38547-00	38547-01	38547-02	38547-00	38547-01	38547-02	38547-00
Instructor Guide: Radar Training Systems	38542-10	38542-11	38542-12	38542-10	38542-11	38542-12	38542-10
User Guide: Radar Processor/Display	38543-E0	38543-E1	38543-E2	38543-E0	38543-E1	38543-E2	38543-E0
RCS/ISAR Measurement Training System	39102-E0	39102-E1	39102-E2	39102-E0	39102-E1	39102-E2	39102-E0

Other Product Literature Available from Lab-Volt:

Lab-Volt Product Catalog on CD-ROM

Descriptions and demonstrations of Lab-Volt training systems and software; includes FACET®, EMS and other award-winning training systems.



Computer-Based Electronics Training System (FACET®) Product Guide

Fifty-two page catalog of Lab-Volt training systems in Fundamental Electronics; Analog, Digital and Fiber Optic Communications; Semiconductors, Transistors, Thyristors, FET and Amplifiers.



Military Training Systems Brochure

State-of-the-art training systems for military applications in telecommunications, radar, electronic warfare, electronics, fluid power, and electric power technologies. Twelve-page color brochure.



Industrial Maintenance Brochure

Twelve-page color brochure showcasing Lab-Volt's comprehensive industrial training systems, including industrial pumps, mechanical systems, industrial wiring, rigging, and more.



Electric Power/Controls Product Guide

Fifty-one page catalog of Lab-Volt's vast offering of training modules in Electro-mechanical systems, PLCs, Power Electronics, and corresponding CBT and simulation software programs.



Wind Power Technology Training Systems Product Guide

Forty-four page color catalog describes the courses and equipment that make up a typical wind power training program and their corresponding CBT and simulation software programs.



Graymark Information Technology Brochure

Eight-page brochure of Graymark's quality IT training products, including PC familiarization, troubleshooting and repair; cable installation; monitor and printer repair; GPS technology; and network technology programs.



Manufacturing/Mechatronics Product Guide

Seventy-eight page catalog of Lab-Volt training programs in Automation and Robotics, Fluid Power, Instrumentation and Process Control, and Refrigeration, Air Conditioning and Heating.



Tech-Design® Foundations in Information Technology (FIT)

Sixteen-page color brochure features this modular, competency-based curriculum for information technology (IT), which provides skills development and career exploration in all IT Career Cluster Concentrations.



TechWorld®: Manufacturing Brochure

Twelve-page color brochure describes this multimedia and hands-on curriculum for engineering and manufacturing; presents competencies students achieve and related career opportunities.



Tech-Design® Technology Education Catalog

Seventy-four-page catalog with detailed descriptions of 43 multimedia and hands-on modules and course objectives, including skills-at-a-glance charts showing competencies associated with each module.



Tech-World®: Manufacturing Demo CD

Highly graphical CD demonstrates this pre-engineering and manufacturing curriculum that provides realistic, hands-on training with industry-standard equipment and advanced software.



4 Easy Ways to Order Additional Product Literature:

- Send e-mail to: us@labvolt.com (USA)
ca@labvolt.com (Canada)
- Call 1-800-LAB-VOLT (USA AND CANADA)
or 1-732-938-2000 (outside of the USA and Canada)
- Visit our website at www.labvolt.com
- Circle the requested items above and fax it:
1-732-774-8573

Please complete the following:

Name _____
Institution _____
Address _____
Address _____
City _____ State _____
Country _____ Postal Code _____

WIND POWER TECHNOLOGY
AUTOMATION & ROBOTICS
FAULT-ASSISTED CIRCUITS FOR ELECTRONICS TRAINING (FACET)
INSTRUMENTATION & PROCESS CONTROL
EXPLORATORY TECHNOLOGY
DIGITAL & MICROPROCESSOR TECHNOLOGY
REFRIGERATION, AIR CONDITIONING & HEATING
TELECOMMUNICATIONS
FLUID POWER
ELECTRICITY & ELECTRONICS
ELECTRIC POWER & CONTROLS



Lab-Volt®

World Leader in
Technical Training Systems